

DOTTORATO DI RICERCA IN MATEMATICA

Adriano FESTA

**Analysis and approximation of  
Hamilton-Jacobi equations with irregular  
data**

PHD THESIS



SAPIENZA - UNIVERSITY OF ROME

a.a. 2010-2011



# Contents

<b>1</b>	<b>Overview of results on Hamilton-Jacobi equations</b>	<b>9</b>
1.1	Viscosity solution . . . . .	9
1.2	The eikonal equation . . . . .	12
1.3	Optimal control problems . . . . .	12
1.3.1	The infinite horizon problem . . . . .	13
1.3.2	The finite horizon problem . . . . .	14
1.3.3	The minimum time problem . . . . .	14
1.3.4	Optimal feedback and trajectories . . . . .	16
1.4	SemiLagrangian approximation for Hamilton-Jacobi equations . . . . .	17
1.4.1	Semi discrete scheme . . . . .	17
1.4.2	Fully discrete scheme . . . . .	18
1.4.3	Time-optimal control . . . . .	20
<b>2</b>	<b>Eikonal equation with discontinuous data</b>	<b>23</b>
2.1	Introduction . . . . .	24
2.2	Well posedness . . . . .	25
2.3	A semiLagrangian approximation . . . . .	29
2.3.1	Semi-discretization in time . . . . .	29
2.3.2	Fully discrete scheme . . . . .	35
2.4	Tests . . . . .	38
<b>3</b>	<b>HJ with discontinuous data</b>	<b>43</b>
3.1	Well-posedness . . . . .	43

3.1.1	The boundary value problem . . . . .	45
3.2	Numerical Approximation . . . . .	48
3.3	Fully Discrete Scheme . . . . .	51
3.4	Examples and Tests . . . . .	54
<b>4</b>	<b>Eikonal equation on Networks</b>	<b>59</b>
4.1	Introduction . . . . .	60
4.2	Assumptions and preliminary results . . . . .	61
4.3	The approximation scheme . . . . .	65
4.3.1	Semi-discretization in time . . . . .	65
4.3.2	Fully discretization in space . . . . .	70
4.4	Implementation of the scheme and numerical tests . . . . .	73
<b>5</b>	<b>Applications</b>	<b>79</b>
5.1	The SFS problem . . . . .	79
5.1.1	The model . . . . .	79
5.1.2	Simulations . . . . .	82
5.2	Optimization problems with state constraints . . . . .	90
5.2.1	Theoretical background . . . . .	90
5.2.2	Simulations . . . . .	92
5.3	Front Propagation in Discontinuous Media . . . . .	102
5.3.1	Theoretical background . . . . .	102
5.3.2	Simulations . . . . .	103

# Introduction

This thesis deals with the development and the analysis of numerical methods for the resolution of first order nonlinear differential equations of Hamilton-Jacobi type on irregular data. The general form of this kind of equation is the following:

$$H(x, u(x), Du(x)) = 0, \quad x \in \Omega \tag{1}$$

where  $\Omega$  is an open domain of  $\mathbb{R}^n$ , or a more complicated domain, as well we will see later, and the Hamiltonian  $H = H(x, r, q)$  is a real valued function on  $\Omega \times \mathbb{R} \times \mathbb{R}^n$ . We will consider some specific cases of Hamiltonian, choices that come from applications,  $H(x, r, q) = |q| - f(x)$  or  $H(x, r, q) = \lambda r + \sup_{a \in A} \{b(x, a) \cdot q - f(x)\}$  with  $f$  measurable and bounded function, possibly discontinuous.

These equations arises for example in the study of front propagation via the level set methods, the Shape-from-Shading problem and other control problems. Control theory is an investigated field of research from the start of XX century, a comprehensive presentation could be found in the well known monograph by Fleming and Rishel [30] or in the more recent book by Vinter [59].

This kind of equations, in general, also for regular data, do not admit a classical solution, so it was developed a weak solution theory, the theory of viscosity solution, initiated in the early 80's by the papers of Crandall, Lions et al. [13, 12]. We remind also the P.L. Lions' influential monograph [41]. In this works it is provided an extremely convenient PDE framework for dealing with the lack of smoothness of the value functions arising in dynamical optimization problems. Very useful, for a global treatment of the results archived in the 80's and the early 90's is the monograph by Bardi and Capuzzo Dolcetta [3]. Several numerical approximation schemes have been proposed by many authors using, for example, Finite Differences, Finite Elements and semiLagrangian techniques. A detailed treatment can be find in Quarteroni and Valli [48], in the articles by Crandall and Lions [14], Souganidis [55] and for semiLagrangian schemes the book by Falcone and Ferretti [27].

The presence of discontinuous terms, or irregular domain involves additional difficulties on the classical analysis and numerical approximation.

The idea of extending the notion of sub- and supersolutions and the comparing principles to semicontinuous functions was introduced by Ishii, Barles, Frankowska et al. in various works, for example [33, 12, 5, 29, 6]. In particular we will use the Ishii's generalized notion of viscosity

solution via semicontinuous envelopes.

The literature about approximation numerical methods for discontinuous Hamilton-Jacobi equations is less wide. We remind the paper by Rouy and Tourin [49], and Ostrov [47] where they deal with problems coming from the Shape-from-shading problem proposing two different numerical schemes. In particular in [49] is presented a consistent and monotone scheme along with numerical calculation and in [47] the unique solution is obtained as the limit of sequences which arise from a suitable regularization of the intensity function. There are also some works that handle the time dependent problem, we mention the work by Tsai, Giga and Osher [57] where the graph of the solution is viewed as the zero level curve of a continuous function in one dimension higher, and the one by Bokanowsky, Forcadel and Zidani [7] for the one-dimensional case, there is presented also an estimation of the error in the  $L^1$ -norm. Finally, we want to mention a paper by Deckelnick and Elliott [18] where there is given a numerical scheme and some error bound for the solution of the eikonal equation case.

Our contribution to the numerical approximation of Hamilton-Jacobi equations consists in the proposal of some semiLagrangian schemes for different kind of discontinuous Hamiltonian and in an analysis of their convergence and a comparison of the results on some test problems. In particular we will approach with an eikonal equation with discontinuous coefficients in a well posed case of existence of Lipschitz continuous solutions. In this case it is possible to prove some error bounds for the approximated solution in the uniform norm. This proof is essentially obtained with a technique of duplication of variables, just like in the continuous case; of course, in this case we will have some additional difficulties and some peculiar issues. Furthermore, we propose a semiLagrangian scheme also for a Hamilton-Jacobi equation of a eikonal type on a ramified space, for example a graph. This is a not classical domain and only in the last two years there are developed a theory about this. In this situation the major difficulty is to deal with the behavior of the solution on a knot, where the problem become, from intrinsically one dimensional, more complicated. At last, we present some applications of our results on several problems arise from applied sciences.

## Outline

The thesis is organized as follows.

Chapter 1 is devoted to the theoretical background necessary to deal with Hamilton-Jacobi equations and viscosity solutions. Particular attention (Section 1.2) is given to the eikonal equation since it appears many times in a number of different contexts. We introduce, in Section 1.3, the Hamilton-Jacobi-Bellman (HJB) equations related to optimal control problems and the minimum time problem. This physical interpretation of HJ equations is crucial to understand many proprieties of the solutions. We present in Section 1.4 a brief introduction of semiLagrangian schemes for this kind of problems.

Chapter 2 is devoted to the original results achieved with regard to approximation of Eikonal equations with discontinuous coefficients. After a short placement of the problem we remind, in Section 2.2 some theoretical results of well posedness due to Soravia which we adapt to our

situation. A comparison theorem entail uniqueness, through an additional Hypothesis on the nature of discontinuities on  $f$ . It is important to remark that, in this case, we have an unique Lipschitz continuous solution. In Section 2.3 we give a semiapproximated numerical scheme and provide an error estimation in the uniform norm. We pass to a fully discrete scheme and we study the convergence and other proprieties of the scheme. We conclude the chapter with a section (Section 2.4) of simulation, where we provide some empirical *a posteriori* estimation of the errors.

Chapter 4 deals in solving an eikonal equation, for example a minimum time problem, on a non conventional domain, a *ramified space*. An interesting case is when this domain is a graph in  $\mathbb{R}^n$ . This model could represent, for example, navigation on a traffic network or in a labyrinth. In Section 4.2 we summarize the definitions and the theoretical results introduced by Camilli and Schieborn in [51]. This concepts are necessary to present, in Section 4.3, an original numerical scheme of semiLagrangian type for this kind of problems. In this section we provide also some results of convergence. Moreover in Section 4.4 we make some simulations and numerical test which show the good performances of the algorithm.

Chapter 5 is dedicated to some applications of our results. In Section 5.1 we use the approaches presented in previous chapters to solve the SFS problem, a classical computer vision matter, where we typically deal with discontinuities on the data. In Section 5.2 we handle with optimization problems with constraints, in particular we show as a constrained problem could be seen as a free problem with discontinuities on the running cost. We deal also with two different applications: solving labyrinths and sail optimization. In Section 5.3 we discuss another typical application which is present in various fields of research, the front propagation in a discontinuous media. In all this sections we show various simulations and tests.





# Chapter 1

## Overview of results on Hamilton-Jacobi equations

In this chapter we present all the definitions and the basic theoretical results we will refer to in the following. First of all we introduce the notion of *viscosity solution* of the Hamilton-Jacobi equation

$$H(x, u(x), Du(x)) = 0, \quad x \in \Omega \quad (1.1)$$

where  $\Omega$  is an open domain of  $\mathbb{R}^n$  and the Hamiltonian  $H = H(x, r, q)$  is a continuous, real valued function on  $\Omega \times \mathbb{R} \times \mathbb{R}^n$ . Later we will discuss further hypothesis on the Hamiltonian. The notion of viscosity solution, allows us to obtain important existence and uniqueness results for some equations of the form (1.1).

For a detailed treatment of all the theoretical elements we refer to [3], by this time, a well known book on this subject.

### 1.1 Viscosity solution

It is well know that equation (1.1) is in general not well-posed. It is possible to show several examples in which no classical (that is of class  $C^1$ ) solution exists or infinite weak (that is *a.e.* differentiable) solutions exist. Even for a very simple 1-dimensional eikonal equation with a Dirichlet boundary condition

$$\begin{cases} |Du(x)| = 1, & x \in (-1, 1) \\ u(x) = 0, & x = \pm 1 \end{cases} \quad (1.2)$$

we can find infinite multiple solutions (see Fig. 1.1). The theory of viscosity solutions was developed in order to overcome these problems. It gives a way to get uniqueness of the solution and in some cases also to select the correct physical solution among all solutions of the equation. We give here two equivalent definitions of viscosity solution.

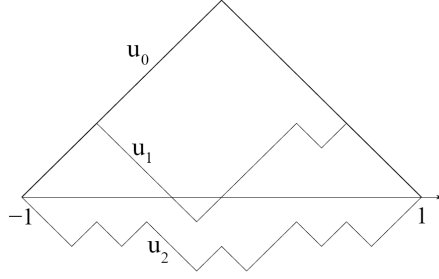

Figure 1.1: Multiple a.e. differentiable solutions of the eikonal equation (1.2).

**Definition 1.1** (I version). *A continuous function  $u$  is a viscosity solution of the equation (1.1) if the following conditions are satisfied:*

- $H(x, u(x), p) \leq 0$  for all  $x \in \mathbb{R}^n$ , for all  $p \in D^+u(x)$  (viscosity subsolution)
- $H(x, u(x), q) \geq 0$  for all  $x \in \mathbb{R}^n$ , for all  $q \in D^-u(x)$  (viscosity supersolution)

where  $D^+$ ,  $D^-$  are super and sub-differential i.e.

$$D^+u(x) = \left\{ p \in \mathbb{R}^n : \limsup_{y \rightarrow x} \frac{u(y) - u(x) - p \cdot (y - x)}{|y - x|} \leq 0 \right\}$$

$$D^-u(x) = \left\{ q \in \mathbb{R}^n : \liminf_{y \rightarrow x} \frac{u(y) - u(x) - q \cdot (y - x)}{|y - x|} \geq 0 \right\}.$$

**Definition 1.2** (II version). *A continuous function  $u$  is a viscosity solution of the equation (1.1) if the following conditions are satisfied:*

- for any test function  $\varphi \in C^1(\Omega)$ , if  $x_0 \in \Omega$  is a local maximum point for  $u - \varphi$ , then

$$H(x_0, u(x_0), D\varphi(x_0)) \leq 0 \quad (\text{viscosity subsolution})$$

- for any test function  $\varphi \in C^1(\Omega)$ , if  $x_0 \in \Omega$  is a local minimum point for  $u - \varphi$ , then

$$H(x_0, u(x_0), D\varphi(x_0)) \geq 0 \quad (\text{viscosity supersolution})$$

The motivation for the terminology “viscosity solutions” is that this kind of solution can be recovered as the limit function  $u = \lim_{\epsilon \rightarrow 0^+} u^\epsilon$  where  $u^\epsilon \in C^2(\Omega)$  is the classical solution of the regularized problem

$$-\epsilon \Delta u^\epsilon + H(x, u^\epsilon, Du^\epsilon) = 0, \quad x \in \Omega \quad (1.3)$$

in the case  $u^\epsilon$  exists and converges locally uniformly to some continuous function  $u$ . This method is named *vanishing viscosity*, and it is the original idea behind this notion of solution. It was presented by Crandall and Lions in [13].

In the following we present some comparison results between viscosity sub- and supersolutions. As simple corollary, each comparison result produces a uniqueness theorem for the associated Dirichlet problem.

**Theorem 1.1.** *Let  $\Omega$  be a bounded open subset of  $\mathbb{R}^n$ . Assume that  $u_1, u_2 \in C(\overline{\Omega})$  are, respectively, viscosity sub- and supersolution of*

$$u(x) + H(x, Du(x)) = 0, \quad x \in \Omega \quad (1.4)$$

and

$$u_1 \leq u_2 \quad \text{on } \partial\Omega. \quad (1.5)$$

Assume also that  $H$  satisfies

$$|H(x, p) - H(y, p)| \leq \omega_1(|x - y|(1 + |p|)), \quad (1.6)$$

for  $x, y \in \Omega$ ,  $p \in \mathbb{R}^n$ , where  $\omega_1$  is a modulus, that is  $\omega_1 : [0, +\infty) \rightarrow [0, +\infty)$  is continuous non decreasing with  $\omega_1(0) = 0$ . Then  $u_1 \leq u_2$  in  $\overline{\Omega}$ .

**Theorem 1.2.** *Assume that  $u_1, u_2 \in C(\mathbb{R}^n) \cap L^\infty(\mathbb{R}^n)$  are, respectively, viscosity sub- and supersolution of*

$$u(x) + H(x, Du(x)) = 0, \quad x \in \mathbb{R}^n. \quad (1.7)$$

Assume also that  $H$  satisfies (1.6) and

$$|H(x, p) - H(x, q)| \leq \omega_2(|p - q|), \quad \text{for all } x, p, q \in \mathbb{R}^n. \quad (1.8)$$

where  $\omega_2$  is a modulus. Then  $u_1 \leq u_2$  in  $\mathbb{R}^n$ .

**Remark 1.1.** *Theorem 1.2 can be generalized to cover the case of a general unbounded open set  $\Omega \subset \mathbb{R}^n$ . Moreover, the assumptions  $u_1, u_2 \in C(\mathbb{R}^n) \cap L^\infty(\mathbb{R}^n)$  can be replaced by  $u_1, u_2 \in UC(\mathbb{R}^n)$ .*

A comparison result can be formulated for the more general case

$$H(x, Du(x)) = 0, \quad x \in \Omega \quad (1.9)$$

only if we assume the convexity of  $H$  with respect to the  $p$  variable. This assumption plays a key role in many theoretical results.

**Theorem 1.3.** *Let  $\Omega$  be a bounded open subset of  $\mathbb{R}^n$ . Assume that  $u_1, u_2 \in C(\overline{\Omega})$  are, respectively, viscosity sub- and supersolution of (1.9) with  $u_1 \leq u_2$  on  $\partial\Omega$ . Assume also that  $H$  satisfies (1.6) and the two following conditions*

- $p \rightarrow H(x, p)$  is convex on  $\mathbb{R}^n$  for each  $x \in \Omega$ ,
- there exists  $\varphi \in C(\overline{\Omega}) \cap C^1(\Omega)$  such that  $\varphi \leq u_1$  in  $\overline{\Omega}$  and  $\sup_{x \in B} H(x, D\varphi(x)) < 0$  for all  $B \subset \Omega$ .

Then  $u_1 \leq u_2$  in  $\Omega$ .

## 1.2 The eikonal equation

The classical model problem for (1.9) is the eikonal equation on geometric optics

$$c(x)|Du(x)| = 1, \quad x \in \Omega \quad (1.10)$$

Theorem 1.3 applies to the eikonal equation (1.10) whenever  $c(x) \in Lip(\Omega)$  and it is strictly positive. In fact the second condition of theorem 1.3 is satisfied by taking  $\varphi(x) \equiv \min_{\overline{\Omega}} u_1$ .

It is easy to prove that the distance function from an arbitrary set  $S \subseteq \mathbb{R}^n$ ,  $S \neq \emptyset$  defined by

$$d_S(x) = d(x, S) := \inf_{z \in S} |x - z| = \min_{z \in \overline{S}} |x - z| \quad (1.11)$$

is continuous in  $\mathbb{R}^n$ . Moreover, for smooth  $\partial S$  it is smooth near  $\partial S$  and satisfies in the classical sense the equation (1.10) in  $\mathbb{R}^n \setminus \overline{S}$  for  $c(x) \equiv 1$ .

For a general set  $S$ , it can be shown that the function  $d_S$  is the unique *viscosity solution* of

$$|Du(x)| = 1, \quad x \in \mathbb{R}^n \setminus \overline{S} \quad (1.12)$$

**Remark 1.2.** *If we consider the eikonal equation in the form  $|Du(x)| = f(x)$  where  $f$  is a function vanishing at last in a single point in  $\Omega$ , then the uniqueness result does not hold. This situation is referred to as degenerate eikonal equation. It can be proved that in this case many viscosity or even classical solution may appear. Consider for example the equation  $|u'| = 2|x|$  for  $x \in (-1, 1)$  complemented by Dirichlet boundary condition  $u = 0$  at  $x = \pm 1$ . It is easy to see that  $u_1(x) = x^2 - 1$  and  $u_2(x) = 1 - x^2$  are both classical solutions. The case of degenerate eikonal equations was been archived by Camilli and Siconolfi [17] and numerically by Camilli and Grüne in [16].*

## 1.3 Optimal control problems

We introduce here the basic notations and theory for optimal control problems, focusing on their relation with Hamilton-Jacobi-Bellman equation. This relation will be useful in the following.

Let us consider the controlled nonlinear dynamical system

$$\begin{cases} \dot{y}(t) = f(y(t), a(t)), & t > 0 \\ y(0) = x \end{cases} \quad (1.13)$$

where:

- $y(t)$  is the state of the system,
- $a(\cdot) \in \mathcal{A}$  is the control of the player,  $\mathcal{A}$  being the set of admissible controls defined as

$$\mathcal{A} = \{a(\cdot) : [0, +\infty) \rightarrow A, \text{ measurable } \},$$

and  $A$  is a given compact set of  $\mathbb{R}^m$ .

Assume hereafter  $f : \mathbb{R}^n \times A \rightarrow \mathbb{R}^n$  is continuous in both variables and there exists a constant  $L > 0$  such that

$$|f(y_1, a) - f(y_2, a)| \leq L|y_1 - y_2| \quad \text{for all } y_1, y_2 \in \mathbb{R}^n, a \in A. \quad (1.14)$$

By Caratheodory's theorem the choice of measurable controls guarantees that for any given  $a(\cdot) \in \mathcal{A}$ , there is a unique trajectory solution of (1.13) which will be denoted by  $y_x(t; a(\cdot))$ .

The final goal is to find an optimal control  $a^*(t)$  such that the corresponding trajectory  $y_x(t; a^*(\cdot))$  is the "most convenient" one with respect to some given criterion, typically minimizing a cost functional, between all possible trajectories starting from  $x$ .

### 1.3.1 The infinite horizon problem

In the infinite horizon problem the *cost functional*  $J$  associated to every trajectory which has to be minimized is

$$J(x, a(\cdot)) = \int_0^\infty l(y_x(t; a(\cdot)), a(t))e^{-\lambda t} dt \quad (1.15)$$

where the *discount coefficient*  $\lambda$  is strictly positive and the running cost  $l(x, a) : \mathbb{R}^n \times A \rightarrow \mathbb{R}$  is continuous in both variables, bounded and there exists  $C > 0$  such that

$$|l(x, a) - l(y, a)| \leq C|x - y| \quad \text{for all } x, y \in \mathbb{R}^n, a \in A. \quad (1.16)$$

We are looking for the *value function*  $v(x)$  defined as

$$v(x) := \inf_{a(\cdot) \in \mathcal{A}} J(x, a(\cdot)) \quad (1.17)$$

and possibly for the optimal control

$$a^*(\cdot) = \arg \min_{a(\cdot) \in \mathcal{A}} J(x, a(\cdot)). \quad (1.18)$$

We have some basic results:

**Proposition 1.1.** *Under the assumption on  $f$  and  $l$  above, the value function  $v$  is bounded and Lipschitz continuous.*

**Proposition 1.2** (Dynamical Programming Principle). *For all  $x \in \mathbb{R}^n$  and  $t > 0$  the value function satisfies*

$$v(x) = \inf_{a(\cdot) \in \mathcal{A}} \left\{ \int_0^t l(y_x(s; a(\cdot)), a(s))a^{-\lambda s} ds + v(y_x(t; a(\cdot)))e^{-\lambda t} \right\}. \quad (1.19)$$

Essentially, the Dynamical Programming Principle says that "an optimal policy has the property that whatever the initial state and the initial decision are, the remaining decisions must constitute an optimal policy with regard to the state resulting from the first decision" [8], where with "decisions" we mean the choice of controls.

**Proposition 1.3.** *The value function  $v$  is a viscosity solution of*

$$\lambda v + \sup_{a \in A} \{-f(x, a) \cdot Dv - l(x, a)\} = 0, \quad x \in \mathbb{R}^n. \quad (1.20)$$

The equation (1.20) is called the Hamilton-Jacobi-Bellman equation for the infinite horizon problem and links optimization problems to Hamilton Jacobi solutions.

### 1.3.2 The finite horizon problem

In the finite horizon problem the *cost functional*  $J$  associated to every trajectory which has to be minimized is

$$J(x, t, a(\cdot)) = \int_0^t l(y_x(s; a(\cdot)), a(s)) e^{-\lambda s} ds + g(y_x(t; a(\cdot))) e^{-\lambda t} \quad (1.21)$$

where  $\lambda \geq 0$ ,  $l(x, a)$  satisfies the same hypothesis as in the infinite horizon case above and the terminal cost  $g : \mathbb{R}^n \rightarrow \mathbb{R}$  is bounded and uniformly continuous. We are looking for the *value function*  $v(x)$  defined as

$$v(x, t) := \inf_{a(\cdot) \in \mathcal{A}} J(x, t, a(\cdot)). \quad (1.22)$$

**Proposition 1.4.** *Under the assumption on  $f, l$  and  $g$  introduced above, the value function  $v$  is bounded and continuous in  $\mathbb{R}^n \times [0, T]$  for all  $T > 0$ .*

**Proposition 1.5** (Dynamic Programming Principle). *For all  $x \in \mathbb{R}^n$  and  $0 < \tau \leq t$  the value function satisfies*

$$v(x, t) = \inf_{a(\cdot) \in \mathcal{A}} \left\{ \int_0^\tau l(y_x(s; a(\cdot)), a(s)) e^{\lambda s} ds + v(y_x(\tau; a(\cdot))) e^{\lambda \tau}, t - \tau \right\}. \quad (1.23)$$

**Proposition 1.6.** *The value function  $v$  is the unique viscosity solution of*

$$\begin{cases} v_t + \lambda v + \sup_{a \in A} \{-f(x, a) \cdot Dv(\cdot, t) - l(x, a)\} = 0 & (x, t) \in \mathbb{R}^n \times (0, +\infty) \\ v(x, 0) = g(x) & x \in \mathbb{R}^n \end{cases} \quad (1.24)$$

The equation (1.24) is called Hamilton-Jacobi-Bellman equation for the finite horizon problem.

### 1.3.3 The minimum time problem

In the minimum time problem the cost associated to every trajectory which has to be minimized is the time needed by the system to reach a given closed *target*  $\mathcal{T} \subset \mathbb{R}^n$ , that is

$$J(x, a(\cdot)) = t_x(a(\cdot)) \quad (1.25)$$

where

$$t_x(a(\cdot)) := \begin{cases} \min \{t : y_x(t; a(\cdot)) \in \mathcal{T}\} & \text{if } y_x(t; a(\cdot)) \in \mathcal{T} \text{ for some } t \geq 0 \\ +\infty & \text{if } y_x(t; a(\cdot)) \notin \mathcal{T} \text{ for all } t \geq 0 \end{cases} \quad (1.26)$$

The *value function* is

$$T(x) := \inf_{a(\cdot) \in \mathcal{A}} t_x(a(\cdot)). \quad (1.27)$$

We will refer to  $T$  also as the minimum time function and we set  $T = 0$  on  $\mathcal{T}$ .

**Definition 1.3.** *The reachable set is  $\mathcal{R} := \{x \in \mathbb{R}^n : T(x) < +\infty\}$ , i.e. it is the set of starting points from which it is possible to reach the target.*

Note that the reachable set depends on the target, the dynamics and on the set of admissible controls and it is not a datum in our problem.

**Proposition 1.7** (Dynamical Programming Principle). *For all  $x \in \mathcal{R}$ ,  $0 \leq t < T(x)$  (so that  $x \notin \mathcal{T}$ ) the value function satisfies*

$$T(x) = \inf_{a(\cdot) \in \mathcal{A}} \{t + T(y_x(t; a(\cdot)))\}. \quad (1.28)$$

Let us derive formally the Hamilton-Jacobi-Bellman equation associated to the minimum time problem from the Dynamical Programming Principle. Rewrite (1.28) as

$$T(x) - \inf_{a(\cdot) \in \mathcal{A}} T(y_x(t; a(\cdot))) = t$$

and divide by  $t > 0$

$$\sup_{a(\cdot) \in \mathcal{A}} \left\{ \frac{T(x) - T(y_x(t; a(\cdot)))}{t} \right\} = 1 \quad \text{for all } t < T(x).$$

We want to pass to the limit as  $t \rightarrow 0^+$ .

Assume that  $T$  is differentiable at  $x$  and  $\lim_{t \rightarrow 0^+}$  commutes with  $\sup_{a(\cdot)}$ . Then, if  $\dot{y}_x(0; a(\cdot))$  exists,

$$\sup_{a(\cdot) \in \mathcal{A}} \{-DT(x) \cdot \dot{y}_x(0; a(\cdot))\} = 1$$

so that, if  $a(0) = a_0$ , we get

$$\max_{a_0 \in A} \{-DT(x) \cdot f(x, a_0)\} = 1 \quad (1.29)$$

Note that in the final equation (1.29) the maximum is taken over  $A$  and not over the set of measurable controls  $\mathcal{A}$ .

The same relation between optimization problems and Hamilton-Jacobi equation can be shown in various different cases. We chose the case of minimum time problem for simplicity.

**Proposition 1.8.** *If  $\mathcal{R} \setminus \mathcal{T}$  is open and  $T \in C(\mathcal{R} \setminus \mathcal{T})$ , then  $T$  is a viscosity solution of*

$$\max_{a \in A} \{-f(x, a) \cdot DT(x)\} - 1 = 0, \quad x \in \mathcal{R} \setminus \mathcal{T} \quad (1.30)$$

Natural boundary conditions for (1.30) are

$$\begin{cases} T(x) = 0 & x \in \partial \mathcal{T} \\ \lim_{x \rightarrow \partial \mathcal{R}} T(x) = +\infty. \end{cases} \quad (1.31)$$

In order to archive uniqueness of the viscosity solution of equation (1.30) is useful an exponential transformation named *Kruzkov transform*

$$v(x) := \begin{cases} 1 - e^{-T(x)} & \text{if } T(x) < +\infty \\ 1 & \text{if } T(x) = +\infty \end{cases} \quad (1.32)$$

It is easy to check (at last formally) that if  $T$  is a solution of (1.30) than  $v$  is a solution of

$$v(x) + \max_{a \in A} \{-f(x, a) \cdot Dv(x)\} - 1 = 0, \quad x \in \mathbb{R}^n \setminus \mathcal{T}. \quad (1.33)$$

This transformation has many advantages.

- The equation for  $v$  has the form (1.4) so that we can apply the uniqueness result already introduced in this chapter.
- $v$  takes value in  $[0, 1]$  whereas  $T$  is generally unbounded (for example if  $f$  vanishes in some points) and this helps in the numerical approximation.
- The domain in which the equation has to be solved is no more unknown.
- One can always reconstruct  $T$  and  $\mathcal{R}$  from  $v$  by the relations

$$T(x) = -\ln(1 - v(x)), \quad \mathcal{R} = \{x : v(x) < 1\}.$$

### 1.3.4 Optimal feedback and trajectories

As mentioned above, the final goal of every control problem, for simplicity we will use the minimum time problem as example, is to find the optimal control

$$a^*(\cdot) = \arg \min_{a(\cdot) \in \mathcal{A}} t_x(a(\cdot)) \quad (1.34)$$

and the associated optimal trajectory, i.e. the solution  $y^*(t)$  of

$$\begin{cases} \dot{y}(t) = f(y(t), a^*(t)), & t > 0 \\ y(0) = x \end{cases} \quad (1.35)$$

The next theorem shows how to compute  $a^*$  in feedback form, i.e. as a function of the state  $y(t)$ . This form is obviously more useful than open-loop optimal control where  $a^*$  depends only on time  $t$ . In fact, the feedback control leads the state to the target even in presence of perturbations and noise.



**Theorem 1.4.** *Let  $T \in C^1(\mathcal{R} \setminus \mathcal{T})$  be the unique solution of (1.30) and define  $a_*(x)$*

$$a_*(x) := \arg \max_{a \in A} \{-f(x, a) \cdot DT(x)\}, \quad x \in \mathcal{R} \setminus \mathcal{T}. \quad (1.36)$$

*Let  $y^*(t)$  be the solution of*

$$\begin{cases} \dot{y}^*(t) = f(y^*(t), a_*(t)), & t > 0 \\ y^*(0) = x \end{cases} \quad (1.37)$$

*Then,  $a^*(t) = a_*(y^*(t))$  is the optimal control.*

## 1.4 SemiLagrangian approximation for Hamilton-Jacobi equations

In this section we recall how to obtain a convergent numerical scheme for Hamilton-Jacobi equations. As a model we will consider infinite horizon problem as described in previous sections. In our approach the numerical approximation is based on a time-discretization of the original control problem via a discrete version of the Dynamical Programming Principle. Then, the functional equation for the time-discrete problem is “projected” on a grid to derive a finite dimensional fixed point problem. We also show how to obtain the same numerical scheme by a direct discretization of the directional derivatives in the continuous equation. Note that the scheme we study is different to that obtained by Finite Difference approximation. In particular, our scheme has a built-in up-wind correction.

### 1.4.1 Semi discrete scheme

The aim of this section is to build a numerical scheme for equation (1.1). In order to do this, we first make a discretization of the original control problem (1.13) introducing a time step  $h = \Delta t > 0$ .

We obtain a discrete dynamical system associated to (1.13) just using any one-step scheme for the Cauchy problem. A well known example is the explicit Euler scheme which corresponds to the following discrete dynamical system

$$\begin{cases} y_{n+1} = y_n + hf(y_n, a_n), & n = 1, 2, \dots \\ y_0 = x \end{cases} \quad (1.38)$$

where  $y_n = y(t_n)$  and  $t_n = nh$ . We will denote by  $y_x(n; \{a_n\})$  the state at time  $nh$  of the discrete time trajectory verifying (1.38). We also replace the cost functional (1.15) by its discretization by a quadrature formula (e.g. the rectangle rule). In this way we get a new control problem in discrete time. The value function  $v_h$  for this problem (the analogous of (1.20)) satisfies the following proposition

**Proposition 1.9** (Discrete Dynamical Programming Principle). *We assume that*

$$\exists M > 0 : |l(x, a)| \leq M \quad \text{for all } x \in \mathbb{R}^n, a \in A \quad (1.39)$$

then  $v_h$  satisfies

$$v_h = \min_{a \in A} \{(1 - \lambda h)v_h(x + hf(x, a)) + l(x, a)\}, \quad x \in \mathbb{R}^n. \quad (1.40)$$

This characterization leads us to a approximation scheme, at this time, discrete only on the temporal variable.

Under the usual assumptions of regularity on  $f$  and  $l$  (Lipschitz continuity, boundness on uniform norm) and for  $\lambda > L$  as in (1.14), the family of functions  $v_h$  is equibounded and equicontinuous, then, by the Ascoli-Arzelà theorem we can pass to the limit and prove that it converges locally uniformly to  $v$ , value function of the continuous problem, for  $h$  going to 0. Moreover, the following estimate holds true,

$$\|v - v_h\|_\infty \leq Ch^{\frac{1}{2}} \quad (1.41)$$

### 1.4.2 Fully discrete scheme

In order to compute an approximate value function and solve (1.40) we have to make a further step: a discretization in space. We need to project equation (1.40) on a finite grind. First of all, we restrict our problem to a compact subdomain  $\Omega \subset \mathbb{R}^n$  such that, for  $h$  sufficiently small

$$x + hf(x, a) \in \bar{\Omega} \quad \forall x \in \bar{\Omega} \quad \forall a \in A \quad (1.42)$$

and we build a regular triangulation of  $\Omega$  denoting by  $X$  the set of its nodes  $x_i, i \in I := \{1, \dots, N\}$  and by  $S$  the set of simplices  $S_j, j \in J := \{1, \dots, L\}$ . Let us denote by  $k$  the size of the mesh i.e.  $k = \Delta x := \max_j \{diam(S_j)\}$ . Note that one can always decide to build a structural grind for  $\Omega$  as it is usual for Finite Difference scheme, although for dynamic programming/semiLagrangian scheme is not an obligation. Main advantage of using structured grind is that one can easily find the simplex containing the point  $x_i + hf(x_i, a)$  for every node  $x_i$  and every control  $a \in A$  and make interpolations.

Now we can define the fully discrete scheme simply writing (1.40) at every node of the grind. We look for a solution of

$$v_h^k(x_i) = \min_{a \in A} \{(1 - \lambda h)I[v_h^k](x_i + hf(x_i, a)) + hl(x_i, a)\}, \quad i = 1, \dots, N \quad (1.43)$$

$$I[v_h^k](x) = \sum_j \lambda_j(x) v_h^k(x_j), \quad 0 \leq \lambda_j(x) \leq 1, \quad \sum_j \lambda_j(x) = 1 \quad x \in \Omega.$$

in the space of piecewise linear functions on  $\Omega$ . Let us make a number of remarks on the above scheme:

1. The function  $u$  is extended on the whole space  $\Omega$  in a unique way by linear interpolation, i.e. as a convex combination of the values of  $v_h^k(x_i)$ ,  $i \in I$ . It should be noted that one can choose any interpolation operator. A study of various results of convergence under various interpolation operators are contained in [26].
2. The existence of (at least) one control  $a^*$  giving the minimum in (1.43) relies on the continuity of the data and on the compactness of the set of controls.
3. By construction,  $u$  belongs to the set

$$W^k := \{w : Q \rightarrow [0, 1] \text{ such that } w \in C(Q), Dw = \text{constant in } S_j, j \in J\} \quad (1.44)$$

of the piecewise linear functions.

We map all the values at the nodes onto a  $N$ -dimensional vector  $V = (V_1, \dots, V_N)$  so that we can rewrite (1.43) in a fixed point form

$$V = F(V) \quad (1.45)$$

where  $F : \mathbb{R}^N \times \mathbb{R}^N$  is defined componentwise as follows

$$[F(V)]_i := \min_{a \in A} \left[ \{(1 - \lambda h) \sum_j \lambda_j (x_i + hf(x_i, a)) V_j\} + hl(x_i, a) \right]_i \quad (1.46)$$

**Theorem 1.5.** *The operator  $F$  defined in (1.46) has the following properties:*

- $F$  is monotone, i.e.  $U \leq V$  implies  $F(U) \leq F(V)$ ;
- $F$  is a contraction mapping in the uniform norm  $\|W\|_\infty = \max_{i \in I} |W_i|$ ,  $\beta \in (0, 1)$

$$\|F(U) - F(V)\|_\infty \leq \beta \|U - V\|_\infty$$

**Corollary 1.1.** *The scheme (1.43) has a unique solution in  $W^k$ . Moreover, the solution can be approximated by the fixed point sequence*

$$V^{(n+1)} = F(V^{(n)}) \quad (1.47)$$

starting from the initial guess  $V^{(0)} \in \mathbb{R}^N$ .

There is, at last, a global estimate for the numerical solution.

**Theorem 1.6.** *Let  $v$  and  $v_h^k$  be the solutions of (1.20) and (1.43). Assume the Lipschitz continuity and the boundness of  $f$  and  $l$ , moreover assume condition (1.42) and that  $\lambda > L_f$ , said  $L_f, L_l$  Lipschitz constant of the function  $f$  and  $l$ , then*

$$\|v - v_h^k\|_\infty \leq Ch^{\frac{1}{2}} + \frac{L_l}{\lambda(\lambda - L_f)} \frac{k}{h}. \quad (1.48)$$

### 1.4.3 Time-optimal control

At now, we introduce a numerical approximation for the solution of the minimum time problem.

After a discretization of the dynamics as in the previous section, let us define the discrete analogue of admissible controls

$$\mathcal{A}^h := \{ \{a_n\}_{n \in \mathbb{N}} : a_n \in A \text{ for all } n \}$$

and that of the reachable set

$$\mathcal{R}^h := \left\{ x \in \mathbb{R}^n : \text{there exists } \{a_n\} \in \mathcal{A}^h \text{ and } \bar{n} \in \mathbb{N} \text{ such that } y_x(\bar{n}; \{a_n\}) \in \mathcal{T} \right\}.$$

Let us also define

$$n_h(x, \{a_n\}) := \begin{cases} \min \{n \in \mathbb{N} : y_x(n; \{a_n\}) \in \mathcal{T}\} & x \in \mathcal{R}^h \\ +\infty & x \notin \mathcal{R}^h \end{cases}$$

and

$$N_h(x) := \inf_{\{a_n\} \in \mathcal{A}^h} n_h(x, \{a_n\}).$$

The discrete analogue of the minimum time function  $T(x)$  is  $T_h(x) := hN_h(x)$

**Proposition 1.10** (Discrete Dynamical Programming Principle). *Let  $h > 0$  fixed. For all  $x \in \mathbb{R}^h$ ,  $0 \leq n < N_h(x)$  (so that  $x \notin \mathcal{T}$ )*

$$N_h(x) = \inf_{\{a_n\} \in \mathcal{A}^h} \{n + N_h(y_x(n; \{a_n\}))\}. \quad (1.49)$$

The proof of the Proposition 1.10 can be found in [4]. Choosing  $n = 1$  in (1.49) and multiplying by  $h$ , we obtain the time-discrete Hamilton-Jacobi-Bellman equation

$$T_h(x) = \min_{a \in A} \{T_h(x + hf(x, a))\} + h. \quad (1.50)$$

Note that we can obtain the equation (1.50) also by a direct discretization of equation (1.30)

$$0 = \max_{a \in A} \{-f(x, a) \cdot DT(x)\} - 1 \approx \max_{a \in A} \left\{ -\frac{T_h(x + hf(x, a)) - T_h(x)}{h} \right\} - 1$$

and, multiplying by  $h$ ,

$$-\min_{a \in A} \{T_h(x + hf(x, a)) - T_h(x)\} - h = -\min_{a \in A} \{T_h(x + hf(x, a))\} + T_h(x) - h = 0.$$

As in continuous problem, we apply the Kruzkov change of variable

$$v_h(x) = 1 - e^{T_h(x)}.$$

Note that, by definition,  $0 \leq v_h \leq 1$  and  $v_h$  has constant values on the set of initial points  $x$  which can be driven to  $\mathcal{T}$  by the discrete dynamical system in the same number of steps (of

constant width  $h$ ). This shows that  $v_h$  is a piecewise constant function. By (1.50) we easily obtain that  $v_h$  satisfies

$$v_h(x) = \min_{a \in A} \{\beta v_h(x + hf(x, a))\} + 1 - \beta.$$

where  $\beta = e^{-h}$  and we have the following

**Proposition 1.11.**  *$v_h$  is the unique bounded solution of*

$$\begin{cases} v_h(x) = \min_{a \in A} \{\beta v_h(x + hf(x, a))\} + 1 - \beta & x \in \mathbb{R}^n \setminus \mathcal{T} \\ v_h(x) = 0 & x \in \partial \mathcal{T} \end{cases} \quad (1.51)$$

Note that the time step  $h$  we introduced for the discretization of the dynamical system is still present in the time-independent equation (1.51) and then it could be interpreted as a fictitious time step.

**Definition 1.4.** *Assume  $\partial \mathcal{T}$  smooth. We say that Small Time Local Controllability (STLC) assumption is verified if*

$$\text{for any } x \in \partial \mathcal{T}, \text{ there exists } \bar{a} \in A \text{ such that } f(x, \bar{a}) \cdot \eta(x) < 0 \quad (1.52)$$

where  $\eta(x)$  is the exterior normal to  $\mathcal{T}$  at  $x$ .

We have the next important result:

**Theorem 1.7.** *Let  $\mathcal{T}$  be compact with nonempty interior. Then under our assumptions on  $f$  and STLC,  $v_h$  converges to  $v$  locally uniformly in  $\mathbb{R}^n$  for  $h \rightarrow 0^+$ .*

Just like in the previous case, we project equation (1.51) on a finite grind. First of all, we restrict our problem to a compact subdomain  $Q$  containing  $\mathcal{T}$  and we build a regular triangulation of  $Q$  with:  $X$  the nodes  $x_i$ ,  $i \in I := \{1, \dots, N\}$ ,  $S$  the set of simplices  $S_j$ ,  $j \in J := \{1, \dots, L\}$ ,  $k$  the size of the mesh.

We will divide the nodes into three subsets.

$$\begin{aligned} I_{\mathcal{T}} &= \{i \in I : x_i \in \mathcal{T}\} \\ I_{in} &= \{i \in I \setminus I_{\mathcal{T}} : \text{there exists } a \in A \text{ such that } x_i + hf(x_i, a) \in Q\} \\ I_{out} &= \{i \in I \setminus I_{\mathcal{T}} : x_i + hf(x_i, a) \notin Q \text{ for all } a \in A\} \end{aligned}$$

Now we can define the fully discrete scheme writing (1.51) on the grind adding the boundary condition on  $\partial Q$

$$\begin{cases} v_h^k(x_i) = \min_{a \in A} \{\beta I[v_h^k](x_i + hf(x_i, a))\} + 1 - \beta & i \in I_{in} \\ v_h^k(x_i) = 0 & i \in I_{\mathcal{T}} \\ v_h^k(x_i) = 1 & i \in I_{out} \end{cases} \quad (1.53)$$

$$I[v_h^k](x) = \sum_j \lambda_j(x) v_h^k(x_j), \quad 0 \leq \lambda_j(x) \leq 1, \quad \sum_j \lambda_j(x) = 1 \quad x \in Q.$$

The condition on  $I_{out}$  assigns to those nodes a value greater than the maximum value inside  $Q$ . It is like saying that once the trajectory leaves  $Q$  it will never come back to  $\mathcal{T}$  (which is obviously false). Nonetheless the condition is reasonable since we will never get the information that the real trajectory (living in the whole space) can get back to the target unless we compute the solution in a larger domain containing  $Q$ . In general, the solution will be correct only in a subdomain of  $Q$  and it is greater than the real solution everywhere in  $Q$ . This means also that the solution we get strictly depends on  $Q$ . Also in this case, by construction,  $v_h^k$  belongs to the set

$$W^k := \{w : Q \rightarrow [0, 1] \text{ such that } w \in C(Q), Dw = \text{constant in } S_j, j \in J\} \quad (1.54)$$

of the piecewise linear functions.

We map all the values at the nodes onto a  $N$ -dimensional vector  $V = (V_1, \dots, V_N)$  so that we can rewrite (1.53) in a fixed point form

$$V = F(V) \quad (1.55)$$

where  $F$  is defined componentwise as follows

$$[F(V)]_i := \begin{cases} \min_{a \in A} \{\beta \sum_j \lambda_j(x_i + hf(x_i, a))V_j\} + 1 - \beta & i \in I_{in} \\ 0 & i \in I_{\mathcal{T}} \\ 1 & i \in I_{out} \end{cases} \quad (1.56)$$

**Theorem 1.8.** *The operator  $F$  defined in (1.56) has the following properties:*

- $F$  is monotone, i.e.  $U \leq V$  implies  $F(U) \leq F(V)$ ;
- $F : [0, 1]^N \rightarrow [0, 1]^N$ ;
- $F$  is a contraction mapping in the uniform norm  $\|W\|_{\infty} = \max_{i \in I} |W_i|$ ,

$$\|F(U) - F(V)\|_{\infty} \leq \beta \|U - V\|_{\infty}$$

**Corollary 1.2.** *The scheme (1.53) has a unique solution in  $W^k$ . Moreover, the solution can be approximated by the fixed point sequence*

$$V^{(n+1)} = F(V^{(n)}) \quad (1.57)$$

starting from the initial guess  $V^{(0)} \in \mathbb{R}^N$ .

A typical choice for  $V^{(0)}$  is

$$V_i^{(0)} = \begin{cases} 0 & i \in I_{\mathcal{T}} \\ 1 & \text{elsewhere} \end{cases} \quad (1.58)$$

which guarantees a monotone decreasing convergence to the fixed point  $V^*$ .

## Chapter 2

# Eikonal equation with discontinuous data

In this chapter we consider a particular class of discontinuous Hamilton-Jacobi equations. We start with an eikonal equation with discontinuities on the data. In spite of the simplicity of this case, there are various applicative situations where we can find this kind of equations.

Let  $\Omega \subset \mathbb{R}^n$  be bounded domain with a Lipschitz boundary  $\partial\Omega$ , we consider the Dirichlet problem

$$\begin{cases} |Du(x)| = f(x) & x \in \Omega \\ u(x) = \varphi(x) & x \in \partial\Omega \end{cases} \quad (2.1)$$

where  $f$  and  $\varphi$  are given functions.

**Motivations.** This equation arises, for example in geometric optics, computer vision or robotic navigation. For instance, in geometric optics, to describe the propagation of lights the eikonal equation appears

$$\sum_{i,j=1}^N a_{ij}(x) u_{x_i} u_{x_j}(x) = g(x) \quad (2.2)$$

where  $a = \sigma\sigma^t$  and  $g$  has the meaning of the refraction index of the medium. As well known, refraction law applies across surfaces of discontinuity of  $g$ . Another example can be found in image processing and the Shape-from-Shading model. In this case we come up with the equation, for a simple situation of vertical light,

$$\sqrt{1 + |Du(x)|^2} = \frac{1}{I(x)} \quad (2.3)$$

and the object to reconstruct is the graph of the unknown function  $u$ . In this case  $I(x) \in (0, 1]$  represent the intensity of light reflected by the object and it is discontinuous when the object has edges. With a bit of convex analysis, both equations above can be rewritten in the form (2.1). Further motivations appears directly in control theory when discontinuous function are

used to represent targets (with  $f$  as a characteristic function) or state constraint (with  $f$  as an indicator function, instead).

To the fact that solution of (2.1) are in general non smooth, they are defined in the sense of the theory of viscosity solutions. Indeed with this notion of solution, when an equation has a discontinuous coefficient, we cannot interpret  $f$  in a pointwise sense. For equation (2.1) it is easily recognized that, even when  $f$  has appropriate discontinuities, value functions will not always satisfy the equation in the viscosity sense if  $f$  is interpreted pointwise. We will focus on this fact by an example in the next section.

In order to define viscosity solutions on this situation, we use appropriate semicontinuous envelopes of  $f$ , applying an idea that was introduced by Ishii on [33].

This chapter is organized as follows: in Section 2.2 we recall some results of well posedness presented in various works, for example in Deckelnick and Elliott [18] or in Soravia []. For a class of  $f$ , which satisfy a suitable one sided continuity condition we have well posedness of the problem (2.1). Later we will build an original scheme of semiLagrangian type for which, in section 2.3 we introduce some results of convergence and error bounds. Finally, in section 2.4 we present some numerical tests.

## 2.1 Introduction

The well posedness of (2.1) in the case of continuous  $f$  follows from the theory of viscosity solutions for HJ equations. We can find the whole treatment on [3] where are summarized the well-known results introduced by Lions, Ishii et al in [34, 13]. The notion of viscosity solution in the case of discontinuous Hamiltonian was proposed by Ishii in [33] where he presents some existence and regularity results. The first results of well-posedness of eikonal equations in the case of discontinuous coefficients on smooth surfaces are been presented on Turin [58], on Newcomb and Su [45], using the Ishii's notion of solution. They obtain a comparison result as well as uniqueness for the Dirichlet problem provided that  $f$  is lower semicontinuous.

From the numerical point of view, the literature is less rich. As state of fact, using traditional numerical schemes developed for regular cases, we can observe that these techniques work well. Anyway, this observation still remain without a clear explication. In 2004 Deckelnick and Elliott [18] proposed a scheme of finite difference type to compute the solution of (2.1). This scheme is very similar to the ones used in the regular case. Moreover, they get some error bounds for the solution.

Our approach was inspired by this work, but we develop our analysis using the techniques appropriate for semiLagrangian schemes, (cfr. for example [25] or appendix A of [3]). We adapt these techniques to this situation where some issues are less regular. For example, the solutions of the semiapproximated problem are not Lipschitz continuous, like in the regular case. However we can reach to some results of convergence and error bounds. The benefits of a semiLagrangian scheme on a Finite Differences one are, as usual, a better ability to follow informations moving through characteristics not aligned to a structural grind. This skill give us a faster and more



accurate approximation in some tricky examples.

## 2.2 Well posedness

We start this section discussing the notion of viscosity solution for the eikonal equation with discontinuous term

$$\begin{cases} |Du(x)| = f(x) & x \in \Omega \\ u(x) = \varphi(x) & x \in \partial\Omega \end{cases} \quad (2.4)$$

where  $\Omega$  is an open bound of  $\mathbb{R}^n$ . We suppose that  $f : \Omega \rightarrow \mathbb{R}$  is Borel measurable and that there exist  $0 < m \leq M < \infty$  such that

$$0 < m \leq f(x) \leq M \quad \forall x \in \Omega \quad (2.5)$$

Furthermore, we will assume an additional condition on  $f$ , on the smoothness of the interfaces of discontinuity. We are going to discuss that later.

In order to define viscosity solutions we need the notion of upper and lower semicontinuous envelopes of a locally bounded function  $v : D \rightarrow \mathbb{R}$ . They are respectively

$$\begin{aligned} v^*(x) &= \lim_{r \rightarrow 0^+} \sup_{\substack{y \in D \\ |y-x| \leq r}} v(y) \\ v_*(x) &= \lim_{r \rightarrow 0^+} \inf_{\substack{y \in D \\ |y-x| \leq r}} v(y) \end{aligned} \quad (2.6)$$

Now we can introduce the generalization of viscosity solutions in this case

**Definition 2.1.** • *A lower semicontinuous function  $u : \Omega \rightarrow \mathbb{R}$  is a viscosity supersolution of (2.4) if for all  $\varphi \in C^1(\Omega)$  and a local minimum point  $x_0$  of  $(u - \varphi)$ , we have*

$$|D\varphi(x_0)| \geq f_*(x_0) \quad (2.7)$$

- *An upper semicontinuous function  $u : \Omega \rightarrow \mathbb{R}$  is a viscosity subsolution of (2.4) if for all  $\varphi \in C^1(\Omega)$  and a local maximum point  $x_0$  of  $(u - \varphi)$ , we have*

$$|D\varphi(x_0)| \leq f^*(x_0) \quad (2.8)$$

- *A continuous function  $u$  is a viscosity solution of (2.4) if is both a supersolution and a subsolution. A viscosity solution  $u : \bar{\Omega} \rightarrow \mathbb{R}$  of (2.4) solves the boundary value problem if moreover it attains the boundary condition.*

Note that the discontinuous term  $f$  is not dealt with pointwise. The following example give us a reason for using semicontinuous envelopes, showing that if  $f$  is dealt with pointwise, the theory is not particular satisfactory. The example is taken from Soravia [54].

**Example 1.** Here we discuss the well-posedness of the 1-D equation

$$|u'(x)| = f(x), \quad x \in [-2, 2], \quad u(-2) = u(2) = 0. \quad (2.9)$$

We will consider two cases where our analysis eventually will show uniqueness of viscosity solutions as defined above. We will try and define viscosity solutions dealing with  $f$  in a pointwise way. Let us consider the case when  $f(x) = 2 - x$  for  $x > 0$  and  $f(x) = 1$  for  $x < 0$ . We can check directly that the function

$$u(x) = \begin{cases} \frac{x^2}{2} - 2x + 2 & x \geq 0 \\ x + 2 & x < 0 \end{cases} \quad (2.10)$$

is solution of the equation when  $f(0) \geq 1$ . If  $u - \varphi$  attains at 0 a maximum point then necessary  $\varphi'(0) \in [-2, 1]$ . It then turns out that  $u$  is a viscosity solution if and only if  $f(0) \geq 2$  and therefore only an upper semicontinuous term  $f$  would be acceptable in this case.

In order to see how easily uniqueness can fail without proper assumptions on  $f$ , now that we accepted that envelopes of function should be used let us consider the same equation (2.9) as above with the choice  $f(x) = 2\chi_{\mathbb{Q}}$ , twice the characteristic function of the rationals. Then one easily checks that both  $u_1 \equiv 0$  and  $u_2 = 2 - 2|x|$  are viscosity solutions.

We continue this section by discussing Lipschitz regularity of the viscosity solution of the boundary problem (2.4) and existence.

**Theorem 2.1.** Let assume (2.5), so, there exists a viscosity solution  $u \in C^{0,1}(\overline{\Omega})$  of the problem (2.4).

*Proof.* Consider the sup-convolution of  $f$ , i.e.

$$f_\epsilon(x) = \sup_{y \in \Omega} \left\{ f(y) - \frac{1}{\epsilon} |x - y|^2 \right\}, \quad x \in \Omega, \epsilon > 0 \quad (2.11)$$

clearly,  $f_\epsilon$  is continuous and  $f^*(x) \leq f_\epsilon(x)$  for all  $x \in \Omega$ . Let

$$L_\epsilon(x, y) := \inf \left\{ \int_0^1 f_\epsilon(\gamma(t)) |\gamma'(t)| dt \text{ s.t. } \gamma \in W^{0,\infty}((0, 1); \Omega) \text{ with } \gamma(0) = x, \gamma(1) = y \right\} \quad (2.12)$$

It is well known that  $u_\epsilon := \inf_{y \in \partial\Omega} L_\epsilon(x, y) + \varphi(y)$  is a solution of

$$\begin{cases} |Du^\epsilon(x)| = f_\epsilon(x) & x \in \Omega \\ u^\epsilon(x) = \varphi(x) & x \in \partial\Omega \end{cases} \quad (2.13)$$

in the viscosity sense. Furthermore, it can be shown that

$$\|u^\epsilon\|_{C^{0,1}(\overline{\Omega})} \leq C(M, \Omega) \quad (2.14)$$

uniformly, in  $\epsilon > 0$ . Thus, there exists a sequence  $(\epsilon_k)_{k \in \mathbb{N}}$  with  $\epsilon_k \searrow 0$ ,  $k \rightarrow \infty$  and  $u \in C^{0,1}(\overline{\Omega})$  such that  $u^{\epsilon_k} \rightarrow u$  uniformly in  $\Omega$  as  $k \rightarrow \infty$ . Using well known arguments from the theory of viscosity solutions one verifies that  $u$  is a solution of (2.4).

This is a classical approach that has been developed by Ishii [34]. □

We now address the uniqueness problem for (2.4). From the example 1, it is clear that uniqueness does not hold, for any choice of  $f$ . In addition of condition (2.5) we introduce a request of regularity on the discontinuities of  $f$ .

We assume that for every  $x \in \Omega$  there exists  $\epsilon_x > 0$  and  $n_x \in S^{n-1}$  so that for all  $y \in \Omega$ ,  $r > 0$  and all  $d \in S^{n-1}$  with  $|d - n_x| < \epsilon_x$  we have

$$f(y + rd) - f(y) \leq \omega(|y - x| + r) \quad (2.15)$$

where  $\omega : [0, \infty) \rightarrow [0, \infty)$  is continuous, non decreasing and satisfies  $\omega(0) = 0$ .

A similar type of condition was used in [58] and [18]. However, condition (2.15) says that is sufficient to estimate values of  $f$  for vectors whose difference is close to a given direction.

We can make an example.

**Example 2.** Suppose that a surface  $\Gamma$  splits  $\Omega$  into two subdomains  $\Omega_1$  and  $\Omega_2$ , that  $f|_{\Omega_1} \in C^0(\Omega_1)$ ,  $f|_{\Omega_2} \in C^0(\Omega_2)$  and that

$$\lim_{\substack{y \rightarrow x \\ y \in \Omega_1}} f(y) < \lim_{\substack{y \rightarrow x \\ y \in \Omega_2}} f(y) \quad \text{for all } x \in \Gamma. \quad (2.16)$$

We observe that if  $\Gamma$  is smooth, automatically condition (2.15) is verified. For Gamma non smooth, a condition that assures (2.15) is the following.

For every  $x \in \Gamma$  there exists a neighborhood  $U_x$  and a cone  $C_x$  such that  $y \in U_x \cap \overline{\Omega_1}$  implies that  $y + C_x \subset \Omega_1$ . Then (2.15) holds with  $n = n_x$  given by the direction of the cone  $C_x$ .

It is not difficult to verify that (2.15) implies

$$f^*(y + rd) - f_*(y) \leq \omega(|y - x| + r) \quad (2.17)$$

for all  $y \in \Omega$ ,  $r > 0$  and  $d \in S^{n-1}$ ,  $|d - n_x| < \epsilon_x$ .

We now introduce a comparison result that come from the ideas contained in Soravia [54].

**Theorem 2.2.** Suppose that  $u \in C^0(\overline{\Omega})$  is a subsolution of (2.4),  $v \in C^0(\overline{\Omega})$  is a supersolution of (2.4) and that at least one of the function belongs to  $C^{0,1}(\overline{\Omega})$ . We suppose also that  $f$  verifies conditions (2.5) and (2.15). So, if  $u \leq v$  on  $\partial\Omega$  then  $u \leq v$  in  $\overline{\Omega}$ .

*Proof.* Let us assume that  $v \in C^{0,1}(\overline{\Omega})$ . Fix  $\theta \in (0, 1)$  and define  $u_\theta(x) := \theta u(x)$ . Next, choose  $x_0 \in \overline{\Omega}$  such that

$$u_\theta(x_0) - v(x_0) = \max_{x \in \overline{\Omega}} (u_\theta(x) - v(x)) =: \mu \quad (2.18)$$

and suppose, for absurd, that  $\mu > 0$ . Upon replacing  $u, v$  by  $u + k, v + k$  we may assume  $u \geq 0$  in  $\overline{\Omega}$ , so that  $u_\theta \leq u$  in  $\overline{\Omega}$ . In particular,  $u_\theta \leq v$  on  $\partial\Omega$ , which implies that  $x_0 \in \Omega$ . Chose  $\epsilon = \epsilon_{x_0}$  and  $n = n_{x_0} \in S^{n-1}$  according to (2.15) and define for  $\lambda > 0$ ,  $L \geq 1$

$$\varphi(x, y) := u_\theta(x) - v(y) - L\lambda|x - y| - \frac{1}{\lambda}|n|^2 - |x - x_0|^2 \quad (x, y) \in \overline{\Omega} \times \overline{\Omega} \quad (2.19)$$

Choose  $(x_\lambda, y_\lambda) \in \overline{\Omega} \times \overline{\Omega}$  such that

$$\varphi(x_\lambda, y_\lambda) = \max_{(x, y) \in \overline{\Omega} \times \overline{\Omega}} \varphi(x, y) \quad (2.20)$$

Since  $x_0 \in \Omega$  we also have  $x_0 - \frac{1}{\lambda}n \in \Omega$  for large  $\lambda$ ; using  $\varphi(x_\lambda, y_\lambda) \geq \varphi(x_0, x_0 - \frac{1}{\lambda}n)$  together with (2.18) we infer

$$\begin{aligned} L\lambda|x_\lambda - y_\lambda - \frac{1}{\lambda}n|^2 + |x_\lambda - x_0|^2 &\leq u_\theta(x_\lambda) - v(y_\lambda) - u_\theta(x_0) + v(x_0 - \frac{1}{\lambda}n) \\ &= (u_\theta(x_\lambda) - v(x_\lambda)) - (u_\theta(x_0) - v(x_0)) + v(x_\lambda) - v(y_\lambda) - v(x_0) + v(x_0 - \frac{1}{\lambda}n) \\ &\leq \text{lip}(v) \left( |x_\lambda - y_\lambda| + \frac{1}{\lambda} \right) \leq \text{lip}(v) \left( |x_\lambda - y_\lambda - \frac{1}{\lambda}n| + \frac{2}{\lambda} \right) \end{aligned}$$

This implies

$$L\lambda|x_\lambda - y_\lambda - \frac{1}{\lambda}n|^2 + |x_\lambda - x_0|^2 \leq \frac{C}{\lambda}$$

where  $C$  depends on  $\text{lip}(v)$  and as consequence

$$\begin{aligned} x_\lambda, y_\lambda &\rightarrow x_0 \quad \text{as } \lambda \rightarrow \infty \\ \lambda|x_\lambda - y_\lambda - \frac{1}{\lambda}n| &\leq \frac{C}{\sqrt{L}} < \frac{\epsilon}{2 + \epsilon} \end{aligned} \quad (2.21)$$

provided that  $L$  is large enough. Suppose that  $u - \frac{1}{\theta}\xi$  has a local maximum in  $x_\lambda$  with  $\xi(x) = v(y_\lambda) + L\lambda|x - y_\lambda - \frac{1}{\lambda}n|^2 + |x - x_0|^2$ . Since  $u$  is subsolution, we may deduce from the relation  $\varphi(x_\lambda, y_\lambda) \geq \varphi(x, y_\lambda)$  for  $x \in \overline{\Omega}$  that

$$|2L\lambda(x_\lambda - y_\lambda - \frac{1}{\lambda}n) + 2(x_\lambda - x_0)| \leq \theta f^*(x_\lambda)$$

for large  $\lambda$ ; similarly

$$|2L\lambda(x_\lambda - y_\lambda - \frac{1}{\lambda}n)| \geq \theta f_*(y_\lambda)$$

Combining the above inequalities, we obtain

$$(1 - \theta)f^*(y_\lambda) \leq 2|x_\lambda x_0| + \theta(f^*(x_\lambda) - f_*(y_\lambda)) \quad (2.22)$$

In order to apply (2.15) we write  $x_\lambda = y_\lambda + r_\lambda d_\lambda$ , where

$$d_\lambda = \frac{n + w_\lambda}{|n + w_\lambda|}, \quad r_\lambda = \frac{1}{\lambda}|n + w_\lambda|, \quad w_\lambda = \lambda(x_\lambda - y_\lambda - \frac{1}{\lambda}n)$$

Recalling (2.21) we deduce

$$|d_\lambda - n| \leq \frac{2|w_\lambda|}{1 - |w_\lambda|} \leq \frac{\frac{2\epsilon}{2+\epsilon}}{1 - \frac{\epsilon}{2+\epsilon}} = \epsilon$$

and (2.17) therefore yields

$$f^*(x_\lambda) - f_*(y_\lambda) = f^*(y_\lambda + r_\lambda d_\lambda) - f_*(y_\lambda) \leq \omega(|y_\lambda - x_0| + r_\lambda) \quad (2.23)$$

If we send  $\lambda \rightarrow \infty$  in (2.22) we finally obtain from (2.5), (2.23) and (2.21) that  $(1 - \theta)m \leq 0$ . That is a contradiction. Thus,  $u_\theta \leq v$  in  $\overline{\Omega}$  and sending  $\theta \nearrow 1$  gives the desired result.  $\square$

## 2.3 A semiLagrangian approximation

### 2.3.1 Semi-discretization in time

Following the approach of [25] we construct an approximation scheme for the equation (2.4).

We prefer to deal with a transformed problem, equivalent to the (2.4), obtained through the Kruzkov's transform. Said  $v(x) = 1 - e^{-u(x)}$  the problem (2.4) become

$$\begin{cases} f(x)v(x) + |Dv(x)| = f(x) & x \in \Omega \\ v(x) = 1 - e^{-\varphi(x)} & x \in \partial\Omega \end{cases} \quad (2.24)$$

to come back to the original function we can use the inverse transform, i.e.  $u(x) = \ln(1 - v(x))$ .

Let us to observe that for  $u(x) \geq 0$ ,  $0 \leq v(x) < 1$ .

For reasons that will be clear in the follow, we write the previous equation in the equivalent way

$$\begin{cases} v(x) + \frac{|Dv(x)|}{f(x)} = 1 & x \in \Omega \\ v(x) = 1 - e^{-\varphi(x)} & x \in \partial\Omega \end{cases} \quad (2.25)$$

We want to build a discrete approximation of (2.25). Let start using the equivalence  $|v(x)| = \max_{a \in B(0,1)} \{a \cdot v(x)\}$ . Let divide, moreover, and get

$$\sup_{a \in B(0,1)} \left\{ \frac{a}{f(x)} \cdot Dv(x) \right\} = 1 - v(x). \quad (2.26)$$

We observe that, in this formulation, it exists a clear interpretation of this equation as the value function of an optimization problem of constant running cost and discount factor equal to one and the modulus of the velocity of the dynamics equal to  $\frac{1}{f(x)}$ .

We discretize the left hand side term of (2.26) as a directional derivative obtaining

$$\sup_{a \in B(0,1)} \left\{ \frac{v_h(x - a \frac{h}{f(x)}) - v_h(x)}{-h} \right\} = 1 - v_h(x). \quad (2.27)$$

Finally, we propose the following discretized problem:

$$\begin{cases} v_h(x) = \frac{1}{1+h} \inf_{\substack{a \in B(0,1) \\ x - a \frac{h}{f(x)} \in \bar{\Omega}}} \left\{ v_h(x - a \frac{h}{f(x)}) \right\} + \frac{h}{1+h} & x \in \Omega \\ v_h(x) = 1 - e^{-\varphi(x)} & x \in \partial\Omega \end{cases} \quad (2.28)$$

where  $h$  is a positive real number.

We have to remark that for  $x \in \Omega$  we have that always the set  $\Omega \cap B(x, \frac{h}{f(x)}) = \left\{ x - a \frac{h}{f(x)} \in \bar{\Omega} \right\} \neq \emptyset$ , (see Figure 2.1). This is true because  $\Omega$  is an open set, so for all  $x \in \Omega$  it exists a ball  $B(x, r) \in \Omega$ . Hence for every  $a$  such that  $|a| < r \frac{m}{h}$  we have that  $x - a \frac{h}{f(x)} \in \Omega$ .

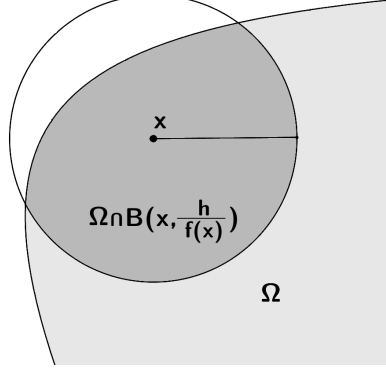

Figure 2.1: The set  $\Omega \cap B(x, \frac{h}{f(x)})$ .

Now we want to show that for  $h \rightarrow 0^+$ , the solution of (2.28) converges to the viscosity solution of (2.25).

To do this, we need a definition and three Lemmas contained in [3] that we recall.

**Definition 2.2.** For the functions  $u_\epsilon : E \rightarrow \mathbb{R}$ ,  $0 < \epsilon \leq 1$ ,  $E \subseteq \mathbb{R}^N$ , the lower weak limit in  $E$  as  $\epsilon \rightarrow 0^+$  at the point  $x \in E$  is

$$\underline{u}(x) = \liminf_{(y, \epsilon) \rightarrow (x, 0^+)} u_\epsilon(y) := \sup_{\delta > 0} \inf \{u_\epsilon(y) : y \in E, |x - y| < \delta \text{ and } 0 < \epsilon < \delta\}$$

the upper weak limit is

$$\bar{u}(x) = \limsup_{(y, \epsilon) \rightarrow (x, 0^+)} u_\epsilon(y) := \sup_{\delta > 0} \sup \{u_\epsilon(y) : y \in E, |x - y| < \delta \text{ and } 0 < \epsilon < \delta\}.$$

**Lemma 2.1.** The lower weak limit  $\underline{u}$  is lower semicontinuous and the upper weak limit  $\bar{u}$  is upper semicontinuous.

**Lemma 2.2.** Let  $u_\epsilon \in USC(E)$  (respectively  $LSC(E)$ ) be locally uniformly bounded  $\varphi \in C^1(E)$ ,  $B := \bar{B}(x_0, r) \cap E$  be closed, and assume  $x_0 \in B$  is a strict maximum (respectively minimum) point for  $\bar{u} - \varphi$  (resp.  $\underline{u} - \varphi$ ) on  $B$ . Then there exists a sequence  $\{x_n\}$  in  $B$  and  $\epsilon_n \rightarrow 0^+$  such that  $x_n$  is a maximum (resp. minimum) point for  $u_{\epsilon_n} - \varphi$  on  $B$  and

$$\lim_n x_n = x_0, \quad \lim_n u_{\epsilon_n}(x_n) = \bar{u}(x_0) \quad (\text{resp. } \underline{u}(x_0)).$$

**Lemma 2.3.** Assume that the functions  $u_\epsilon$  satisfy  $\sup_K |u_\epsilon| \leq C_K$  on every compactum  $K \subseteq \Omega$  and

$$\underline{u} = \bar{u} =: u \quad \text{on } K$$

Then  $u_\epsilon \rightarrow u$  uniformly on  $K$  as  $\epsilon \rightarrow 0^+$ .

Now we are ready to show the following theorem. We have to remark that, instead the continuous case, the family of solutions  $u_h$  are not Lipschitz continuous, moreover, they are not continuous at all, in general. So we have to take a particular care on it.

**Theorem 2.3.** *Let assume the Hypothesis of Theorem 2.2. We have that*

$$\sup_{\Omega} |v_h(x) - v(x)| \rightarrow 0 \text{ with } h \rightarrow 0^+.$$

*Proof.* It is immediate check that

$$\sup_{\Omega} |v_h(x)| \leq 1.$$

Let us define the functions  $\underline{v}$ ,  $\bar{v}$  by

$$\underline{v}(x) = \liminf_{(y,h) \rightarrow (x,0^+)} v_h(y), \quad \bar{v}(x) = \limsup_{(y,h) \rightarrow (x,0^+)} v_h(y).$$

By Lemma 2.1  $\underline{v}$ ,  $\bar{v}$  are, respectively, lower semicontinuous and upper semicontinuous, and satisfy

$$\underline{v} \leq \bar{v} \text{ in } \Omega \tag{2.29}$$

Let us assume temporarily that  $\underline{v}$  is viscosity supersolution and  $\bar{v}$  is viscosity subsolution of (2.25). Then by the comparison principle, Theorem 2.2 we obtain

$$\bar{v} \leq \underline{v} \text{ in } \Omega$$

Taking (2.29) into account, then  $\bar{v} \equiv \underline{v}$ . Therefore  $v := \bar{v} = \underline{v}$  turns out to be a continuous viscosity solution of (2.25) and also by Lemma 2.3

$$v_h \rightarrow v \text{ locally uniformly in } \Omega \text{ as } h \rightarrow 0^+$$

which proves the theorem.

Let us show then that  $\underline{v}$  is a viscosity supersolution of (2.25).

Let  $x_1$  be a strict minimum point for  $\underline{v} - \psi$  in  $\bar{B} = \overline{B(x_1, r)}$ ,  $\psi \in C^1(\mathbb{R}^N)$ . By Lemma 2.2 there exists  $x_n \in \bar{B}$  and  $h_n \rightarrow 0^+$  such that

$$(v_{h_n} - \psi)(x_n) = \min_{\bar{B}} (v_{h_n} - \psi), \quad x_n \rightarrow x_1, \quad v_{h_n}(x_n) \rightarrow \underline{v}(x_1). \tag{2.30}$$

Since  $v_h$  solves (2.28) we obtain

$$v_h(x_n) - v_h \left( x_n - a_n \frac{h_n}{f(x_n)} \right) = h_n (1 - v_h(x_n)) \tag{2.31}$$

for some  $a_n = a_n(x_n)$ . Using (2.30) we know that

$$v_h(x_n) - v_h \left( x_n - a_n \frac{h_n}{f(x_n)} \right) \leq \psi(x_n) - \psi \left( x_n - a_n \frac{h_n}{f(x_n)} \right)$$

so the equation (2.31) becomes

$$\psi(x_n) - \psi\left(x_n - a_n \frac{h}{f(x_n)}\right) \geq h_n (1 - v_h(x_n))$$

for sufficient small  $h_n$ . Divide now by  $h_n > 0$ , take a subsequence  $n_k$  such that  $a_{n_k} \rightarrow \bar{a} \in B(0, 1)$  and let  $k \rightarrow +\infty$  to obtain

$$\frac{\bar{a}}{f(x_1)} \cdot D\psi(x_1) \geq 1 - \underline{v}(x_1),$$

and so

$$\bar{a} \cdot D\psi(x_1) \geq f(x_1) (1 - \underline{v}(x_1)) \geq f_*(x_1) (1 - \underline{v}(x_1)),$$

This implies that  $\underline{v}$  is a viscosity supersolution of (2.25).

Now let  $x_0$  be a strict maximum point for  $\bar{v} - \psi$  on  $\bar{B} := \bar{B}(x_0, r)$ . By Lemma (2.2) again, there exist  $x_n \in \bar{B}$ ,  $h_n \rightarrow 0^+$ , such that

$$(v_{h_n} - \psi)(x_n) = \max_{\bar{B}}(v_{h_n} - \psi), \quad x_n \rightarrow x_0, \quad v_{h_n}(x_n) \rightarrow \bar{v}(x_0). \quad (2.32)$$

From this we obtain

$$v_h(x_n) - v_h\left(x_n - a_n \frac{h_n}{f(x_n)}\right) \geq \psi(x_n) - \psi\left(x_n - a_n \frac{h_n}{f(x_n)}\right)$$

and again

$$\psi(x_n) - \psi\left(x_n - a_n \frac{h}{f(x_n)}\right) \leq h_n (1 - v_h(x_n)).$$

Divide now by  $h_n > 0$ , take a subsequence  $n_k$  such that  $a_{n_k} \rightarrow \bar{a} \in B(0, 1)$  and let  $k \rightarrow +\infty$

$$\bar{a} \cdot D\psi(x_0) \leq f(x_0) (1 - \bar{v}(x_0)) \geq f^*(x_0) (1 - \bar{v}(x_0)),$$

This shows that  $\bar{v}$  is a subsolution. □

We have seen that  $\sup_{\Omega} |v_h - v| \rightarrow 0$  as  $h \rightarrow 0^+$ . The next result shows that rate of convergence can be estimated under a condition on discontinuities a bit stronger than (2.15).

We assume that there exist  $\eta > 0$  and  $K \geq 0$  such that for all  $x \in \Omega$  there is a direction  $n = n_x \in S^{n-1}$  with

$$f(y + rd) - f(y) \leq Kr \quad (2.33)$$

for all  $y \in \Omega$ ,  $d \in S^{n-1}$ ,  $r > 0$  with  $|y - x| < \eta$ ,  $|d - n| < \eta$  and  $y + rd \in \Omega$ .

**Theorem 2.4.** *Let assume the Hypothesis of Theorem 2.2 and moreover (2.33).*

*We have that*

$$\sup_{\Omega} |v_h(x) - v(x)| \leq C\sqrt{h} \quad \text{for all } h > 0$$

*for some constant  $C > 0$  independent from  $h$ .*



*Proof.* If  $x \in \partial\Omega$  the assumption is trivially verified because of Dirichlet boundary conditions.

Let  $x \in \Omega$ . Consider for  $\epsilon > 0$  the auxiliary function

$$\psi(x, y) := v(x) - v_*(y) - \frac{|x - y|^2}{2\epsilon}$$

where  $v_* := (v_h)_*$ . It is not hard to check that the boundness of  $v$ ,  $v_*$  and the upper semicontinuity of  $\psi$ , implies the existence of some  $(\bar{x}, \bar{y})$  (depending on  $\epsilon$ ) such that

$$\psi(\bar{x}, \bar{y}) \geq \psi(x, y) \quad \text{for all } x, y \in \Omega$$

We suppose, at now, that  $\text{dist}(\bar{y}, \partial\Omega) > \frac{h}{f(\bar{y})}$ . Different cases will be discussed later.

The inequality  $\psi(\bar{x}, \bar{y}) \geq \psi(0, 0)$  immediately gives

$$\frac{|\bar{x} - \bar{y}|^2}{2\epsilon} \leq B\epsilon \tag{2.34}$$

with  $B = 2(\sup_{\Omega} |v(x)| + \sup_{\Omega} |v_*(x)|)$ . Now use  $\psi(\bar{x}, \bar{y}) \geq \psi(\bar{y}, \bar{y})$  to get, on the account of the Lipschitz continuity of  $v(x)$

$$\frac{|\bar{x} - \bar{y}|^2}{2\epsilon} \leq v(\bar{x}) - v(\bar{y}) \leq B|\bar{x} - \bar{y}| \tag{2.35}$$

By (2.34) we have that  $|\bar{x} - \bar{y}| \leq \sqrt{2\epsilon B} < 1$  for a small  $\epsilon$ . Hence (2.35) leads to the estimate

$$|\bar{x} - \bar{y}| \leq B'\epsilon.$$

By equation (2.28) we have

$$v_* \left( x - \bar{a} \frac{h}{f(x)} \right) = v_*(x) + hv_*(x) - h \tag{2.36}$$

for some  $\bar{a} = \bar{a}(\bar{y})$ . This equation is valid also if  $\text{dist}(x, \partial\Omega) \leq \frac{h}{f(x)}$  because, as we explained in a previous part  $a \in \left\{ B(0, 1) \mid x - a \frac{h}{f(x)} \in \bar{\Omega} \right\}$ . On the other hand since

$$x \longrightarrow w(x) - [w_h(\bar{y}) + \frac{|x - \bar{y}|^2}{2\epsilon}]$$

has a maximum at  $\bar{x}$ , from (2.25) we obtain

$$\frac{|\bar{x} - \bar{y}|}{\epsilon} \leq f^*(\bar{x}) - f^*(\bar{x})v(\bar{x}) \tag{2.37}$$

and then

$$v(\bar{x}) \leq 1 - \frac{|\bar{x} - \bar{y}|}{\epsilon f^*(\bar{x})} \tag{2.38}$$

The inequality  $\psi(\bar{x}, \bar{y}) \geq \psi(\bar{x}, \bar{y} - \bar{a} \frac{h}{f(\bar{y})})$  gives

$$-v_*(\bar{y}) - \frac{|\bar{x} - \bar{y}|^2}{2\epsilon} \geq -v_*(\bar{y} - \bar{a} \frac{h}{f(\bar{y})}) - \frac{|\bar{x} - \bar{y} + \bar{a} \frac{h}{f(\bar{y})}|^2}{2\epsilon}$$

so

$$-v_*(\bar{y}) - \frac{|\bar{x} - \bar{y}|^2}{2\epsilon} \geq -v_*(\bar{y} - \bar{a} \frac{h}{f(\bar{y})}) - \frac{\bar{a}h}{f(\bar{y})} \left[ \frac{ah}{2\epsilon f(\bar{y})} + \frac{\bar{a} \cdot (x - y)}{\epsilon} \right]$$

and then

$$v_*(\bar{y} - \bar{a} \frac{h}{f(\bar{y})}) \geq v_*(\bar{y}) - \frac{h}{f(\bar{y})} \left[ \frac{h}{2\epsilon f(\bar{y})} + \frac{|\bar{x} - \bar{y}|}{\epsilon} \right]$$

and substituting the left hand side term with (2.36)

$$v_*(\bar{y}) \geq 1 - \left[ \frac{h}{2\epsilon f^2(\bar{y})} + \frac{|\bar{x} - \bar{y}|}{f(\bar{y})\epsilon} \right]$$

Now, add this to (2.37)

$$\begin{aligned} v(\bar{x}) - v_*(\bar{y}) &\leq \frac{|\bar{x} - \bar{y}|}{\epsilon} \left( \frac{1}{f(\bar{y})} - \frac{1}{f^*(\bar{x})} \right) + \frac{h}{2\epsilon f^2(\bar{y})} \\ &= \frac{|\bar{x} - \bar{y}|}{\epsilon} \left( \frac{f^*(\bar{x}) - f(\bar{y})}{f(\bar{y})f^*(\bar{x})} \right) + \frac{h}{2\epsilon f^2(\bar{y})} \leq \frac{|\bar{x} - \bar{y}|}{\epsilon} \left( \frac{f^*(\bar{x}) - f_*(\bar{y})}{m^2} \right) + \frac{h}{2\epsilon f^2(\bar{y})}. \end{aligned}$$

We have now, give an estimate of  $f^*(\bar{x}) - f_*(\bar{y})$ . We use the assumption (2.33) with  $\eta = 2\sqrt{\epsilon}$ . To do this, let us write  $\bar{x} = \bar{y} + r_\epsilon d_\epsilon$  with

$$d_\epsilon = \frac{n + w_\epsilon}{|n + w_\epsilon|}, \quad r_\epsilon = \epsilon|n + w_\epsilon|, \quad w_\epsilon = \frac{1}{\sqrt{\epsilon}}(\bar{x} - \bar{y})$$

We remind that  $|\bar{x} - \bar{y}| \leq \epsilon$  we have that

$$f^*(\bar{x}) - f_*(\bar{y}) \leq K r_\epsilon = K\epsilon|n + w_\epsilon| \leq K\epsilon|n| + \sqrt{\epsilon}\epsilon = \epsilon(K + \sqrt{\epsilon}) \leq K\epsilon \quad (2.39)$$

which estimation holds true because of

$$|d_\epsilon - n| \leq \frac{2|w_\epsilon|}{1 - |w_\epsilon|} = \frac{2|\bar{x} - \bar{y}|}{\sqrt{\epsilon} - |\bar{x} - \bar{y}|} \leq \frac{2\epsilon}{\sqrt{\epsilon} - \epsilon} \leq \frac{2\sqrt{\epsilon}}{1 - \sqrt{\epsilon}} \leq 2\sqrt{\epsilon}. \quad (2.40)$$

Finally, choosing  $\epsilon = \sqrt{h}$  we obtain

$$v(\bar{x}) - v_*(\bar{y}) \leq C\sqrt{h}$$

For  $C$  suitable positive constants. Then the inequality  $\psi(\bar{x}, \bar{y}) \geq \psi(x, x)$  yields

$$v(x) - v_h(x) \leq v(x) - v_*(x) \leq v(\bar{x}) - v_*(\bar{y}) \leq Ch \quad (2.41)$$

for all  $x \in \Omega$ . To prove the inequality  $v_h(x) - v(x) \leq Ch$  it is enough to interchange the roles of  $v$  and  $v_h$  on the auxiliary function  $\psi$ . We take

$$\varphi(x, y) := v(x) - v^*(y) + \frac{|x - y|^2}{2\epsilon}$$

where  $v^* := (v_h)^*$ . For the boundness of  $v$ ,  $v^*$  and the lower semicontinuity of  $\varphi$ , we know that exists a  $(\bar{x}, \bar{y})$  (depending on  $\epsilon$ ) such that

$$\varphi(\bar{x}, \bar{y}) \leq \varphi(x, y) \quad \text{for all } x, y \in \Omega$$

we can make again all the argument, changing the side of the disequations. We obtain

$$v(x) - v_h(x) \geq v(x) - v^*(x) \geq v(\bar{x}) - v_*(\bar{y}) \geq -Ch \quad (2.42)$$

for all  $x \in \Omega$ .

Results (2.41) and (2.42) give, together the thesis.

### 2.3.2 Fully discrete scheme

In this section we introduce a FEM like discretization of (2.28) yielding a fully discrete scheme.

Let us assume that  $\Omega = \Pi_{i=1}^n(a_i, b_i)$  and that the grind size  $\Delta x > 0$  is chosen in such a way that  $b_i - a_i = N_i \Delta x$  for some  $N_i \in \mathbb{N}$ ,  $i = 1, \dots, n$ . We then define

$$\Omega_{\Delta x} := \mathbb{Z}_{\Delta x}^n \cap \Omega, \quad \partial\Omega_{\Delta x} := \mathbb{Z}_{\Delta x}^n \cap \partial\Omega, \quad \bar{\Omega}_{\Delta x} := \Omega_{\Delta x} \cup \partial\Omega_{\Delta x}$$

where  $\mathbb{Z}_{\Delta x}^n = \{x_\alpha = (a_1 + \Delta x \alpha_1, \dots, a_n + \Delta x \alpha_n) \mid \alpha_i \in \mathbb{Z}, i = 1, \dots, n\}$ .

We look for a solution of

$$\begin{cases} W(x_\alpha) = \frac{1}{1+h} \min_{a \in B(0,1)} I[W](x_\alpha - a \frac{h}{f(x_\alpha)}) + \frac{h}{1+h} & x_\alpha \in \Omega_{\Delta x} \\ W(x_\alpha) = 1 - e^{-\varphi(x_\alpha)} & x_\alpha \in \partial\Omega_{\Delta x} \end{cases} \quad (2.43)$$

where  $I[W](x)$  is a linear interpolation of  $W$  on the point  $x$ , in the space of piecewise linear functions on  $\bar{\Omega}$

$$\mathcal{W}^{\Delta x} := \{w : \bar{\Omega} \rightarrow \mathbb{R} \mid w \in C(\Omega) \text{ and } Dw(x) = c_\alpha \text{ for any } x \in (x_\alpha, x_{\alpha+1})\}.$$

**Remark 2.1.** *The existence of (at last) one control  $a^*$  giving the minimum in (2.43) is not so simple in this case from the fact that the set  $B = \left\{x_\alpha - a \frac{h}{f(x_\alpha)}\right\}$  is not compact. We can bypass this difficulty considering the minimum on the closure of the set  $B$ . Note also that the search of a global minimum over  $B$  is not an easy task. Let us underline that when  $A$  (in this case  $B(0,1) = A$ ) is finite (e.g.  $A \equiv \{a_1, \dots, a_n\}$ ), the minimum can be obtained by direct comparison at each node. So one simple way to solve the problem is to replace  $A$  by a finite set of controls constructing a mesh over  $A$ . In this case we can prove (as in [3]) that the optimal controls are bang-bang, so a careful discretization (essentially only of the boundary of  $A$ ) can give accurate results.*

The above scheme was examined for continuous  $f$  in some works like [3], [25].

**Theorem 2.5.** *Let  $x_\alpha - ha \in \bar{\Omega}$ , for every  $x_\alpha \in \Omega_{\Delta x}$ , for any  $a \in B(0, 1)$ , so there exists a unique solution  $W$  of (2.43) in  $\mathcal{W}^{\Delta x}$*

*Proof.* By our assumption, starting from any  $x_\alpha \in \bar{\Omega}_{\Delta x}$  we will reach points which still belong to  $\Omega$ . So, for every  $w \in \mathcal{W}^{\Delta x}$  we have

$$w(x_\alpha - a \frac{h}{f(x_\alpha)}) = \sum_{j=1}^L \lambda_{\alpha j}(a) w(x_j)$$

where  $\lambda_{\alpha j}(a)$  are the coefficients of the convex combination representing the point  $x_\alpha - a \frac{h}{f(x_\alpha)}$ , and  $L$  the number of nodes of  $\bar{\Omega}_{\Delta x}$ , i.e.

$$x_\alpha - a \frac{h}{f(x_\alpha)} = \sum_{j=1}^L \lambda_{\alpha j}(a) x_j \quad (2.44)$$

now we observe

$$0 \leq \lambda_{\alpha j}(a) \leq 1 \quad \text{and} \quad \sum_{j=1}^L \lambda_{\alpha j}(a) = 1 \quad \text{for any } a \in B(0, 1) \quad (2.45)$$

Then (2.43) is equivalent to the following fixed point problem in finite dimension

$$W = T(W)$$

where the map  $T : \mathbb{R}^L \rightarrow \mathbb{R}^L$  is defined componentwise as

$$(T(W))_\alpha := \left[ \frac{1}{1+h} \min_{a \in B(0,1)} \Lambda(a)W + \frac{h}{1+h} \right]_\alpha \quad \alpha \in 1, \dots, L$$

$W_\alpha \equiv W(x_\alpha)$  and  $\Lambda(a)$  is the  $L \times L$  matrix of the coefficients  $\lambda_{\alpha j}$  satisfying (2.44), (2.45) for  $\alpha, j \in 1, \dots, L$ .

$T$  is a contraction mapping. In fact, let  $\bar{a}$  be a control giving the minimum in  $T(V)_\alpha$ , we have

$$\begin{aligned} [T(W) - T(V)]_\alpha &\leq \frac{1}{1+h} [\Lambda(\bar{a})(W - V)]_\alpha \\ &\leq \frac{1}{1+h} \max_{\alpha, j} |\lambda_{\alpha j}(\bar{a})| \|W - V\|_\infty \leq \frac{1}{1+h} \|W - V\|_\infty \end{aligned}$$

Switching the role of  $W$  and  $V$  we can conclude that

$$\|T(W) - T(V)\|_\infty \leq \frac{1}{1+h} \|W - V\|_\infty$$

□

The solution of (2.43) has the following crucial proprieties:

- *Consistency.* From (2.43) we obtain

$$W(x_\alpha) - \frac{1}{h} \min_{a \in B(0,1)} \left\{ -W(x_\alpha) + I[W](x_\alpha - a \frac{h}{f(x_\alpha)}) \right\} = 1$$

We can see the term on the minimum as a first order approximation of the directional derivative

$$- \min_{a \in B(0,1)} \{ -a \cdot DW \} + o(h) = 1 - W(x_\alpha)$$

using  $\max(\cdot) = -\min(-\cdot)$  we find the consistency, that is of order  $o(h + \Delta x)$ .

- *Convergence and monotonicity.* Since  $T$  is a contraction mapping in  $\mathbb{R}^N$ , the sequence

$$W^n = T(W^{n-1}),$$

will converge to  $W$ , for any  $Z \in \mathbb{R}^N$ . Moreover, the following estimate holds true:

$$\|W^n - W\|_\infty \leq \left( \frac{1}{1+h} \right)^n \|W_0 - W\|_\infty.$$

We suppose  $W^n(x_\alpha) < V^n(x_\alpha)$  for every  $(x_\alpha) \in \Omega_h$ . We have that  $W^{n+1}(x_\alpha) < V^{n+1}(x_\alpha)$  from

$$\begin{aligned} W^{n+1}(x_\alpha) - V^{n+1}(x_\alpha) &= \\ &= \frac{1}{1+h} \min_{a \in B(0,1)} I[W](x_\alpha - a \frac{h}{f(x_\alpha)}) + \frac{h}{1+h} \\ &\quad - \frac{1}{1+h} \min_{a \in B(0,1)} I[V](x_\alpha - a \frac{h}{f(x_\alpha)}) - \frac{h}{1+h} = \\ &= \frac{1}{1+h} \left( \min_{a \in B(0,1)} I[W](x_\alpha - a \frac{h}{f(x_\alpha)}) - \min_{a \in B(0,1)} I[V](x_\alpha - a \frac{h}{f(x_\alpha)}) \right) \leq \\ &= W(x_\beta) - V(x_\beta) < 0 \end{aligned}$$

We want now, to give an error bound between the solution of the semi discretized problem  $w_h$  and the solution of the fully discrete one  $W$ , in order to give a estimate for the approximation error in the  $L_\infty(\Omega)$  norm.

**Theorem 2.6.** *Let  $v_h$  and  $W$  be the solutions of (2.28) and (2.43). We have*

$$\|v_h - W\|_\infty \leq C(1+h) \frac{\Delta x}{h} \tag{2.46}$$

said  $C$  a positive constant.

*Proof.* For any  $x \in \Omega$  we can write

$$|v_h(x) - W(x)| \leq \left| \sum_j \lambda_j (v_h(x) - v_h(x_j)) \right| + \left| \sum_j \lambda_j v_h(x_j) - W(x_j) \right|$$

where the  $\lambda_j$  are the coefficients of a convex combination. By the equations, we have

$$v_h(x_j) - W(x_j) \leq \frac{1}{1+h} \left[ v_h(x_j + \bar{a} \frac{h}{f(x_j)}) - W(x_j + \bar{a} \frac{h}{f(x_j)}) \right] \leq \frac{1}{1+h} \|v_h - W\|_\infty$$

Now, we have to show the Lipschitz continuity of  $v_h$ , we can use the classical techniques presented, for example, in [3]. We briefly sketch the idea.

We introduce a notion of distance  $L(x, y)$  as in the proof of Theorem (2.1)

$$L(x, y) := \inf \left\{ \int_0^1 f(\gamma(t)) |\gamma'(t)| dt \text{ s.t. } \gamma \in W^{0,\infty}((0, 1); \Omega) \text{ with } \gamma(0) = x, \gamma(1) = y \right\} \quad (2.47)$$

we know that for a small  $\epsilon > 0$

$$v_h(x) \leq v_h(y) + L(x, y) + \epsilon$$

and in the same time

$$v_h(y) \leq v_h(x) + L(y, x) + \epsilon$$

afterwards

$$|v_h(x) - v_h(y)| \leq L(x, y) + \epsilon \leq m|x - y| + \epsilon$$

for  $\epsilon \rightarrow 0$  we have the Lipschitz continuity of  $v_h$ . Now we can say that

$$|v_h(x) - v_h(x_j)| \leq C\Delta x.$$

Coupling the results

$$\|v_h - W\|_\infty \leq \frac{1}{1+h} \|v_h - W\|_\infty + C\Delta x.$$

we conclude

$$\|v_h - W\|_\infty \leq \frac{1+h}{h} (C\Delta x)$$

□

## 2.4 Tests

In this section we present some results of numerical calculations for (2.1). As the first test example, let  $\Omega := (-1, 1) \times (0, 2)$  and  $f : \Omega \rightarrow \mathbb{R}$  be defined by

$$f(x_1, x_2) := \begin{cases} 1 & x_1 < 0, \\ 3/4 & x_1 = 0 \\ 1/2 & x_1 > 0 \end{cases} \quad (2.48)$$

It is not difficult to see that  $f$  satisfies (2.15). Furthermore, let  $\varphi := 0$  on  $\partial\Omega$ .

In figure 2.3 are presented the results on our approximation.

In our second example we consider  $\Omega = (-1, 1)^2$ ,  $\varphi = 0$  and

$$f(x_1, x_2) := \begin{cases} 2, & (x_1 - \frac{1}{2})^2 + x_2^2 \leq \frac{1}{8} \text{ and } x_2 \geq x_1 - \frac{1}{2}, \\ 3, & (x_1 - \frac{1}{2})^2 + x_2^2 \leq \frac{1}{8} \text{ and } x_2 < x_1 - \frac{1}{2}, \\ 1, & \text{otherwise.} \end{cases}$$

Note that in this case, discontinuities of  $f$  occur both along curved lines and along a straight line witch is not aligned with the grind. Furthermore, the three regions, in which  $f$  takes different values, meet at the triple points  $(3/4, 1/4)$ ,  $(1/4, -1/4)$ . It is not difficult to check that  $f$  satisfies (2.15). The results are displayed in figure 2.3.

For our next test, we take the same situation than in the first test. Let  $\Omega := (-1, 1) \times (0, 2)$  and  $f : \Omega \rightarrow \mathbb{R}$  defined like in (2.48). We can verify that the function

$$u(x_1, x_2) := \begin{cases} \frac{1}{2}x_2, & x_1 \geq 0, \\ -\frac{\sqrt{3}}{2}x_1 + \frac{1}{2}x_2, & -\frac{1}{\sqrt{3}}x_2 \leq x_1 \leq 0, \\ x_2, & x_1 < -\frac{1}{\sqrt{3}}x_2. \end{cases}$$

if a viscosity solution of  $|Du| = f(x)$  in the sense of our definition. Furthermore, let be  $\varphi := u|_{\partial\Omega}$ . We show in the table 2.4 and in figure 2.4 our results.

$\Delta x = h$	$\ \cdot\ _\infty$	$Ord(L_\infty)$	$\ \cdot\ _1$	$Ord(L_1)$
<b>0.1</b>	1.7346		0.0811	
<b>0.05</b>	0.8039	1.1095	0.0326	1.3148
<b>0.025</b>	0.5359	0.5851	0.0183	0.8330
<b>0.0125</b>	0.3055	0.8108	0.0079	1.2119

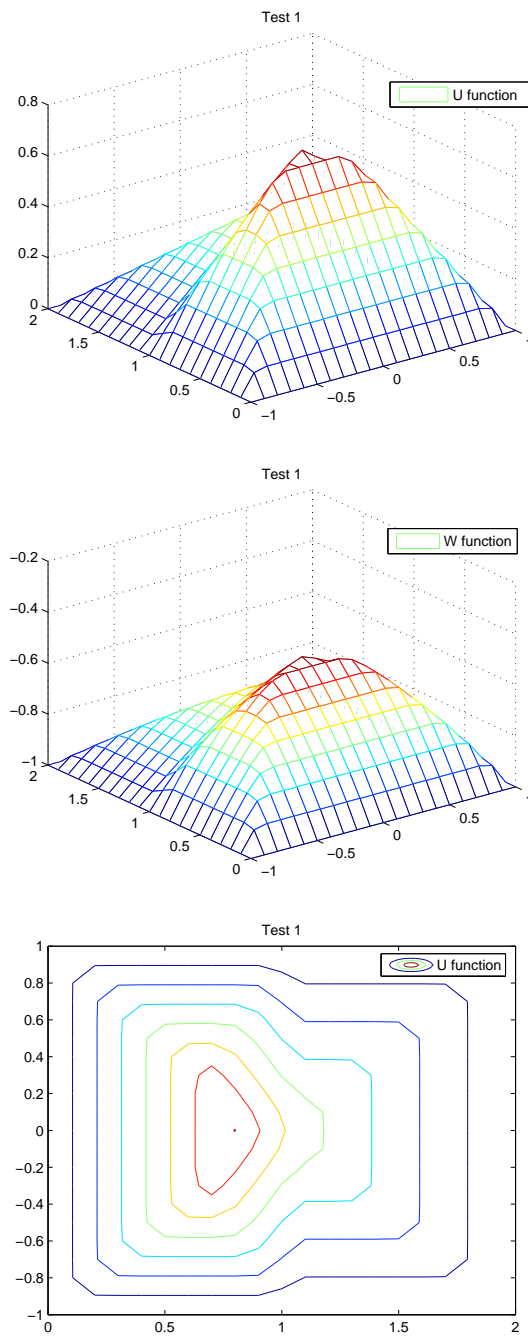

Figure 2.2: Test1.



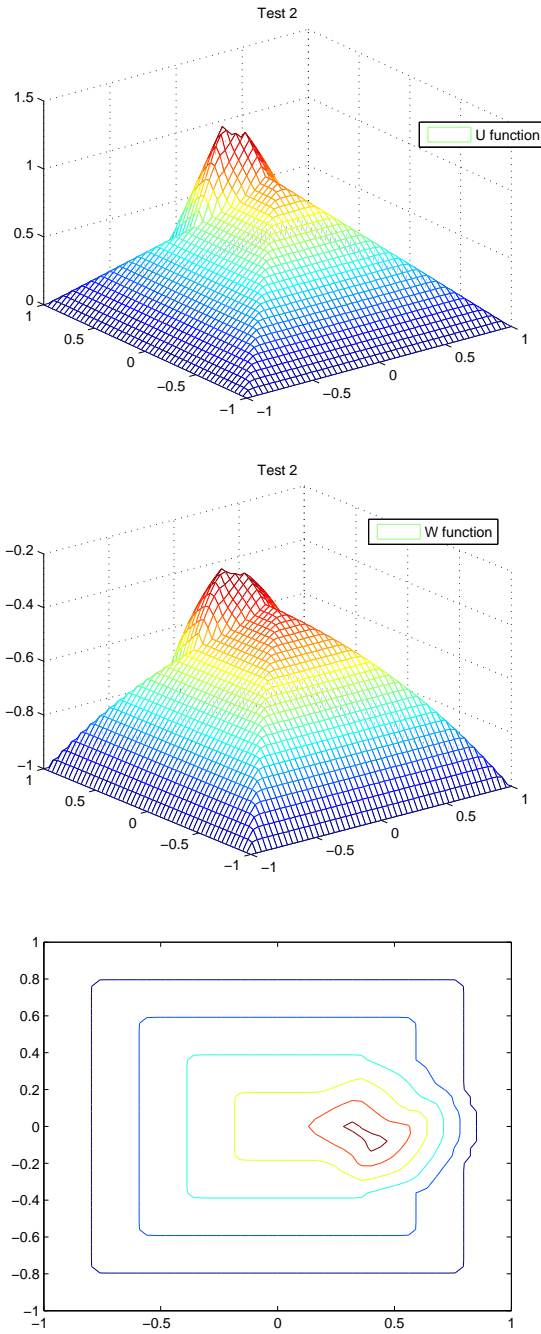

Figure 2.3: Test2.

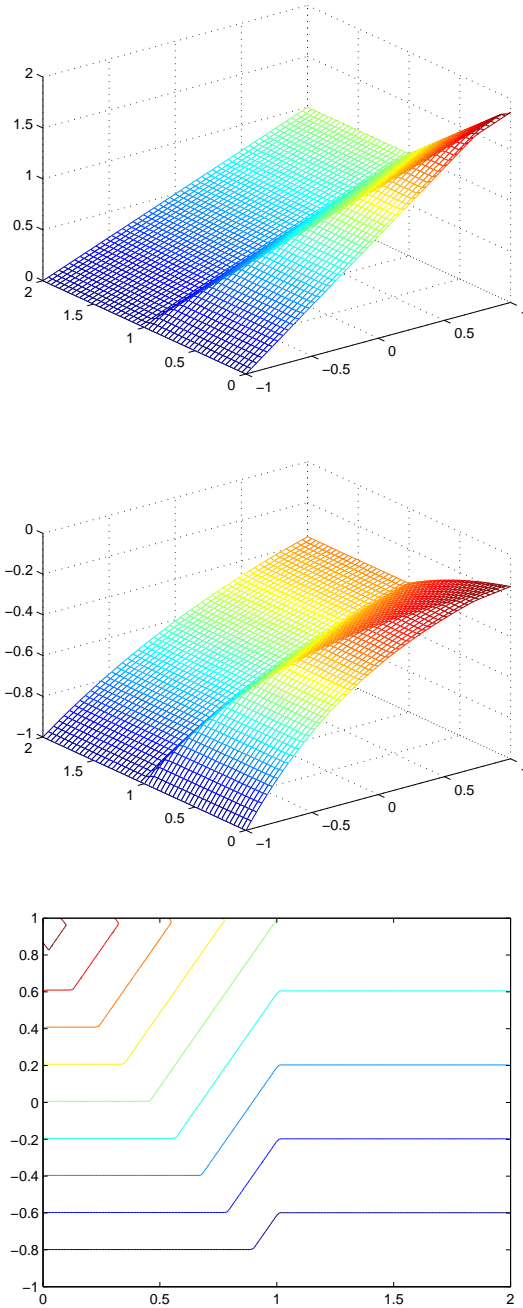

Figure 2.4: Test3.

## Chapter 3

# HJ with discontinuous data

### 3.1 Well-posedness

We remind some theoretical elements of the control problem associated to this kind of equations. We consider the following dynamical system

$$\begin{cases} \dot{y}(t) = b(y(t), a(t)), \\ y(0) = x \end{cases} \quad (3.1)$$

where  $b : \mathbb{R}^N \times A \rightarrow \mathbb{R}^N$  is a continuous function and  $A$  is a compact subset of a metric space. The control function is taken in  $\mathcal{A}$ , the set of the measurable functions  $a(\cdot) : \mathbb{R}^+ \rightarrow A$ . We study the optimal control problem of the previous dynamic with respect to the running cost

$$J(t, x, a) = \int_0^t e^{-\lambda s} [g(y_x(s), a(s)) + f(y_x(s))] ds. \quad (3.2)$$

Moreover, we require the following regularity hypothesis

$$\begin{cases} |b(x, a) - b(y, a)| \leq L|x - y|, & x, y \in \mathbb{R}^N, a \in A \\ |g(x, a) - g(y, a)| \leq L_R|x - y|, & |x|, |y| \leq R, a \in A \end{cases} \quad (3.3)$$

where  $L, L_R$  are positive constants. It follows that, for a given  $a \in \mathcal{A}$  e  $x \in \mathbb{R}$ , there is an unique global solution of (3.1) which we call, for simplicity,  $y_x(t; a) \equiv y(\cdot)$ .

We introduce, at now, the concept of viscosity solution in the discontinuous case. This definition use the concept of semicontinuous envelope and was introduced by Ishii in [33].

We denote the Hamiltonian

$$H(x, p) := \sup_{a \in A} \{-b(x, a) \cdot p - g(x, a)\} \quad (3.4)$$

Let  $\Omega$  be a subset of  $\mathbb{R}^N$ . Let us consider the following Hamilton-Jacobi equation

$$\lambda u(x) + H(x, Du(x)) = f(x), \quad x \in \Omega \quad (3.5)$$

here and in the continuation  $\lambda \geq 0$  and  $f : \Omega \rightarrow \mathbb{R} \cup \{+\infty, -\infty\}$  is a Borel measurable function. Later we will need of the notion of upper and lower semicontinuous envelope of a function  $v : \Omega \rightarrow \mathbb{R} \cup \{+\infty, -\infty\}$ . They are, respectively,

$$v^*(x) = \lim_{r \rightarrow 0^+} \sup_{|y-x| \leq r} v(y), \quad y \in \Omega \quad (3.6)$$

$$v_*(x) = \lim_{r \rightarrow 0^+} \inf_{|y-x| \leq r} v(y), \quad y \in \Omega. \quad (3.7)$$

Viscosity solutions of the Hamilton-Jacobi equation (3.5) with discontinuous and extended real-valued coefficients are defined as follows. Note that solutions are defined in two different ways. The definitions are not equivalent in the general case, this will play a role, according to the regularity of the problem.

**Definition 3.1.** • A lower semicontinuous function  $U : \Omega \rightarrow \mathbb{R} \cup \{+\infty\}$  (resp. upper semicontinuous  $V : \Omega \rightarrow \mathbb{R} \cup \{-\infty\}$ ) is a viscosity super- (resp. sub-) solution of (3.5) if for all  $\varphi \in C^1(\Omega)$  and  $x \in \text{dom}(U)$  a local minimum point of  $(U - \varphi)$ , (resp.  $x \in \text{dom}(V)$  a local maximum point of  $(V - \varphi)$ ), we have

$$\lambda U(x) + H(x, D\varphi(x)) \geq f_*(x), \quad (\lambda U(x) + H(x, D\varphi(x)) \leq f^*(x)) \quad (3.8)$$

- A lower semicontinuous function  $U : \Omega \rightarrow \mathbb{R} \cup \{+\infty\}$  is a lower semicontinuous subsolution (lsc-subsolution for short) of (3.5) if it is a viscosity supersolution of

$$-\lambda U(x) - H(x, D\varphi(x)) = -f_*(x). \quad (3.9)$$

- A locally bounded function  $U$  is a (standard) viscosity solution of (3.5) if  $U_*$  is a supersolution and  $U^*$  is a subsolution.
- A lower semicontinuous function  $U$  is a lsc-solution (or a bilateral supersolution following [3]) if it is a supersolution and a lsc-subsolution of (3.5).

The concept of lsc solution was introduced by Barron and Jensen [6] and is different from the standard one of Crandall-Lions' viscosity solution (when applied to discontinuous solutions with the Ishii's generalization). It is a crucial notion, however, when dealing with boundary value problem in order to characterize a unique solution without local controllability assumptions on  $f$  at the boundary, even when  $g$  is continuous, see [53].

We define the exit time of the trajectories of (3.1) from the open set  $\Omega \subset \mathbb{R}^N$

$$\tau_x \equiv \tau_x(a) := \inf\{t \geq 0 \mid y_x(t; a) \notin \Omega\} \quad (\leq +\infty). \quad (3.10)$$

The main goal contained on various articles by Soravia (see [54]) is to show that viscosity super and sub-solutions of (3.5) can be characterized by implicit representation formulas that use the data of the Hamiltonian along the solutions of (3.1). This idea can be viewed as a weak form of the method of characteristics. These representation formulas are called *optimality principles*. Value functions of optimal control problems satisfy optimality principles basically by the dynamical

programming principle. The main fact is that the assumption on the data do not guarantee a comparison principle for the differential equation (3.5).

Let's remind the definition of optimality principles.

**Definition 3.2.** *We say that  $u$  satisfies the upper optimality principle in  $\Omega$  with respect to the optimal control problem for system (3.1), set of admissible controls  $\mathcal{A}$  and running cost  $g + f$  if*

$$u(x) = \inf_{a \in \mathcal{A}} \sup_{t \in [0, \tau_x[} \left\{ \int_0^t e^{-\lambda s} [g(y_x(s), a(s)) + f_*(y_x(s))] ds + e^{-\lambda t} u(y_x(t)) \right\} \quad (3.11)$$

for all  $x \in \Omega$ .

*We say that  $u$  satisfies the lower optimality principle in  $\Omega$  if*

$$u(x) = \inf_{a \in \mathcal{A}} \inf_{t \in [0, \tau_x[} \left\{ \int_0^t e^{-\lambda s} [g(y_x(s), a(s)) + f^*(y_x(s))] ds + e^{-\lambda t} u(y_x(t)) \right\} \quad (3.12)$$

for all  $x \in \Omega$ .

Let's see, now, the link between optimality principles and viscosity solutions:

**Proposition 3.1.** *Assuming (3.3), we have:*

1. *Let  $f : \Omega \rightarrow \mathbb{R} \cup \{+\infty\}$  be bounded from below and let  $U$  be a lower semicontinuous viscosity supersolution of (3.5), bounded from below. Then  $U$  satisfies (3.11).*
2. *Let  $f : \Omega \rightarrow \mathbb{R} \cup \{-\infty\}$  be locally bounded from above. Let  $U$  be either an upper semicontinuous viscosity subsolution or an lsc-subsolution of (3.5). Then  $U$  satisfies (3.12). (3.5). Then  $U$  satisfies (3.12).*

### 3.1.1 The boundary value problem

At now, we consider the boundary value problem

$$\begin{cases} \lambda u(x) + H(x, Du(x)) = f(x), & x \in \Omega \\ u(x) = \psi(x), & x \in \partial\Omega \end{cases} \quad (3.13)$$

where possibly  $\Omega = \mathbb{R}^N$ . Of course, if  $\Omega = \mathbb{R}^N$  then the boundary condition disappears, otherwise the boundary value is always supposed to be compatible with respect to the data in (3.13). This means that the boundary condition is obtained by restricting on  $\partial\Omega$  a function  $\psi : \mathbb{R}^N \rightarrow \mathbb{R}$  which is lower semicontinuous and satisfies

$$\psi(x) = \inf_{a \in \mathcal{A}} \inf_{t \geq 0} \left\{ \int_0^t e^{-\lambda s} [g(y_x(s), a(s)) + f^*(y_x(s))] ds + e^{-\lambda t} \psi(y_x(t)) \right\} \quad (3.14)$$

for all  $x \in \mathbb{R}^N$ . Equivalently, we can ask that  $\psi$  is a viscosity supersolution of

$$-\lambda\psi(x) - H(x, D\psi(x)) = -f_*(x). \quad (3.15)$$

In the case  $\Omega = \mathbb{R}^N$  the meaning of viscosity super and subsolution of (3.13) of course is as in Definition (3.1), otherwise we define next what super and subsolutions of the boundary value problem are, with respect to a compatible boundary data  $\psi$ . Again we give two definitions of solutions according to how we prescribe the boundary condition to be attained, whether pointwise or in a generalized sense.

**Definition 3.3.** • *A supersolution of (3.13) is a lower semicontinuous function  $u$  which is a viscosity supersolution of the pde in (3.13) and such that  $u \geq \psi$  on  $\partial\Omega$ .*

- *Subsolutions are upper semicontinuous functions and are defined correspondingly.*
- *A lsc subsolution of (3.13) is a lower semicontinuous function which is a viscosity supersolution of*

$$-\lambda u(x) - H(x, Du(x)) \geq -f^*(x), \quad x \in \mathbb{R}^N$$

*and such that  $u = \psi$  in  $\mathbb{R}^N \setminus \Omega$ .*

- *A viscosity solution of (3.13) is a function  $u : \bar{\Omega} \rightarrow \mathbb{R}$  that is viscosity solution of the pde in (3.13) and continuously attains the Dirichlet boundary condition.*
- *A lsc solution (or bilateral supersolution) of the boundary value problem (3.13) is a lower semicontinuous function  $u : \bar{\Omega} \rightarrow \mathbb{R}$  that is viscosity solution of the pde in (3.13) and continuously attains the Dirichlet boundary condition.*

We proceed by discussing the existence of maximal subsolutions and minimal supersolutions of (3.13). To this end we introduce the two following value functions of optimal control problems corresponding to the boundary value problem (3.13). They are respectively

$$V_m(x) = \inf_{a \in \mathcal{A}} \int_0^{\tau_x(a)} e^{-\lambda t} (g(y_x(t), a(t)) + f_*(y(t))) dt + \chi_{\{t|t < +\infty\}}(\tau_x(a)) e^{-\lambda \tau_x(a)} \psi(y_x(\tau_x(a))) \quad (3.16)$$

$$V_M(x) = \inf_{a \in \mathcal{A}} \int_0^{\tau_x(a)} e^{-\lambda t} (g(y_x(t), a(t)) + f^*(y(t))) dt + \chi_{\{t|t < +\infty\}}(\tau_x(a)) e^{-\lambda \tau_x(a)} \psi(y_x(\tau_x(a))). \quad (3.17)$$

We can note that:

- $V_m(x) \leq V_M(x)$
- $(V_m)_*$ ,  $(V_M)_*$  are lsc-solutions
- $V_m$ ,  $V_M$  are viscosity solutions, if they are bounded and continuous on  $\partial\Omega$ .

The following weak comparison results holds, a consequence of the optimality principles.

**Proposition 3.2.** • Suppose that  $g$  is bounded from below and let  $U : \bar{\Omega} \rightarrow \mathbb{R} \cup \{+\infty\}$  be a viscosity supersolution, bounded from below of (3.13). We require that  $U$  is nonnegative if  $\lambda = 0$ . Then

$$U(x) \geq V_m(x) \quad \forall x \in \Omega \quad (3.18)$$

Thus  $V_m$  is lower semicontinuous and the minimal viscosity supersolution of (3.13) bounded from below.

- Suppose that  $g$  is locally bounded from above, and let  $U$  be an upper semicontinuous viscosity subsolution, or a lower semicontinuous lsc-subsolution of (3.13), respectively. We also assume that  $U$  is bounded from above if  $\lambda > 0$  (or that  $g(x, a) > 0$ ,  $f(x) \geq c > 0$  if  $\lambda = 0$ ). Then

$$U(x) \leq V_M(x) \quad \forall x \in \Omega \quad (3.19)$$

Thus, if  $(V_M)^*$  is finite, bounded from above if  $\lambda > 0$ , and  $(V_M)^* \leq \psi$  on  $\partial\Omega$ , then it is the maximal viscosity subsolution of (3.13). Moreover,  $(V_M)_*$  is the maximal lsc-subsolution.

The following statement is now straightforward.

**Corollary 3.1.** Let assume the hypothesis of the proposition 3.2,

- if  $U$  is a viscosity solution of (3.13) that continuously attains the boundary data  $\psi$  on  $\partial\Omega$  then  $V_m \leq U_* \leq U \leq U^* \leq V_M$  in  $\Omega$ . In particular, if at  $x \in \Omega$  we have  $V_m(x) = V_M(x)$ , then  $U$  is continuous at  $x$ .
- If  $U$  is lsc-solution of the boundary problem (3.13) then  $V_m \leq U \leq (V_M)_*$ .

The previous results explain the roles of the definitions of viscosity solution and lsc-solution, and give explicit representation formulas for the minimal supersolution and maximal subsolution as value functions of optimal control problems related to the pde that we want to solve.

At now, therefore, the question of uniqueness for (3.13) is reduced to a mere control theoretic question: is it true that  $V_m$  and  $V_M$  are both finite, satisfy the prescribed boundness and sign conditions, and that  $V_m \equiv V_M$  (o for lsc-solutions  $V_m \equiv (V_M)_*$ )?

It is clear that this is not always true, in particular uniqueness turns out to be hopeless if the discontinuity set of  $f$  has nonempty interior. However, we will obtain a necessary and sufficient condition for the unique solution.

Let us consider a point  $x \in \Omega$  and a sequence  $x_n \rightarrow x$  and  $(a_n)_{n \in \mathbb{N}}$  such that

$$\lim_{n \rightarrow +\infty} \int_0^{\tau_{x_n}(a_n)} e^{-\lambda t} (g(y_{x_n}(t), a_n(t)) + f_*(y_{x_n}(t))) dt + \chi_{\{t|t < +\infty\}}(\tau_{x_n}(a_n)) e^{-\lambda \tau_{x_n}(a_n)} \psi(y_{x_n}(\tau_{x_n}(a_n))) = V_m(x) \quad (3.20)$$

in this case a necessary and sufficient condition for the uniqueness of lsc-solution is the following:

$$\lim_{n \rightarrow +\infty} \int_0^{\tau_{x_n}(a_n)} e^{-\lambda t} (f_*(y_{x_n}(t)) - f^*(y_{x_n}(t))) dt \quad (3.21)$$

So, we state:

**Theorem 3.1.** *Let assume the hypothesis of the proposition 3.2, and let  $V_m(x)$  be finite. We have that  $V_m(x) = (V_M)_*(x)$  if and only if (3.21) holds. Therefore a lsc-solution (bilateral solution) is unique if and only if (3.21) holds for all  $x \in \Omega$ .*

Condition (3.21) can be made slightly more readable. In fact if we suppose  $a \in \mathcal{A}$  is an optimal control for  $V_m(x)$  and  $f_*(y_x(\cdot, a)) = f^*(y_x(\cdot, a))$  almost everywhere, then (3.21) holds.

Let end discussing an explicit result of uniqueness We have to add some hypothesis, considering a simpler, less general case. Let consider a class of Hamiltonians, where  $\lambda \geq 0$ , the vector fields is simply  $b(x, a) = a$ ,  $h \geq 0$  is continuous, bounded and satisfies (3.3). Suppose, further, that the set of controls  $A$  is convex, compact and that contains a ball  $\mathbb{R}^N \supset A \supset B_r(0)$  for a  $r > 0$ . Moreover, we also restrict ourselves to special discontinuities of  $f$ . We will consider an open subset with nonempty boundary  $\Omega \subset \mathbb{R}^N$ ,  $N \geq 2$ , and suppose that

$$\bar{\Omega} = \bigcup_{i=1}^m \bar{\Omega}_i \quad (3.22)$$

where each  $\Omega_i$  is an open, connected domain with Lipschitz boundary,  $\bar{\Omega}_i \cap \bar{\Omega}_j = \partial\Omega_i \cap \partial\Omega_j$  if  $i \neq j$ , and each  $x \in \Omega$  belongs to at most two subdomains  $\bar{\Omega}_i$ . We will suppose that the discontinuous coefficient  $f : \bar{\Omega} \rightarrow [c, +\infty[$ ,  $c > 0$ , is lower semicontinuous and locally bounded from above. Moreover, we suppose that it is continuous in each  $\Omega_i$ , that near the boundary of the subdomain  $f$  assumes a constant value  $f_i$  and that, for  $x \in \partial\Omega_i$ ,

$$f(x) = \liminf_{(\Omega \setminus K) \ni y \rightarrow x} f(y) \quad (3.23)$$

where  $K = \bigcup_{i=1}^m \partial\Omega_i$ .

**Theorem 3.2.** *In the assumptions above, the boundary value problem (3.13) has a unique (standard and lsc) viscosity solution.*

## 3.2 Numerical Approximation

We want, in this section, to build some numerical approximations for the results of the previous section, in particular we want to make some approximation schemes for the minimal supersolution (3.16) and the maximal subsolution (3.17). Obviously, on the cases where there is uniqueness we will have a coincidence of these two approximations, respectively a.e. coincidence on the uniqueness case of lsc-solution, and punctual coincidence on the case of viscosity solution.

Let introduce a result that we will use in the following.

**Proposition 3.3.** *We call  $f : [a, b] \rightarrow [-M, M]$  a function lower semicontinuous with a finite number  $\{x_j\}$ ,  $j = 1, \dots, m$  of isolated points of discontinuity, in the rest of the domain  $C^1$ . Taking a  $\Delta x > 0$  we call  $A_i$  the  $i$ -interval of an uniform discretization of  $[a, b]$  (i.e.  $A_0 = [a, a + \Delta x]$ ,*



$A_1 = [a + h, a + 2h] \dots A_i = [a + i\Delta x, a + (i + 1)\Delta x]$ , and  $f_i = f_*(a + i\Delta)$ . We have that, for  $C > 0$ , the following estimation holds:

$$\left| \sum_{i=0}^n f_i A_i - \int_a^b b(x) dx \right| \leq C \Delta x \quad (3.24)$$

hence, we have that  $\left| \sum f_i A_i - \int_a^b b(x) dx \right| \xrightarrow{\Delta x \rightarrow 0} 0$ .

*Proof.* We make a discretization of the interval  $[a, b]$  with a constant step  $\Delta x$ . Hence,  $x_0 = a, x_1 = a + \Delta x, x_2 = a + 2\Delta x, \dots, x_n = b$ . Now, considering a family of intervals  $A_i = [x_i, x_{i+1}]$  the  $m$  points of discontinuity will fall, at the most, on  $m$  intervals  $A_i$ . We divide these intervals on the collection  $B_j = [x_i, x_{i+1}]$ ,  $j = 0..n - m - 1$  where the function  $f$  is regular (i.e. said  $B = \cup_j B_j$ ,  $f \in C^2(B)$ ) and  $C_j = (x_i, x_{i+1})$ ,  $j = 0..m - 1$  where we have some discontinuities, we call  $\Gamma = \cup_j C_j$ . At now, we have, for the triangle inequality, that

$$\left| \sum_{i=0}^n f_i A_i - \int_a^b f(x) dx \right| \leq \left| \sum_{i=0}^{n-m} f_i B_i - \int_B f(x) dx \right| + \left| \sum_{i=0}^m f_i C_i - \int_{\Gamma} f(x) dx \right| \quad (3.25)$$

it is well known that there exist some prior estimations for the quadrature formulas on regular functions. In this case, taken an interval  $[\alpha, \beta]$  such that  $f(x) \in C^1([\alpha, \beta])$  we know that the mean value theorem hold, it means that

$$(x - \alpha) f'(y_x) = f(x) - f(\alpha) \quad (3.26)$$

for some  $y_x \in [\alpha, x]$ . If we integrate on  $x$  from  $\alpha$  to  $\beta$  both the terms and we take the absolute value, we obtain

$$\left| \int_{\alpha}^{\beta} f(x) dx - (\beta - \alpha) f(\alpha) \right| = \left| \int_{\alpha}^{\beta} (x - \alpha) f'(y_x) \right| \quad (3.27)$$

We can, moreover, estimate the term on the right hand side of the identity, taking the absolute value of the term and replacing  $f'$  with a upperbound. That is

$$\left| \int_{\alpha}^{\beta} f(x) dx - (\beta - \alpha) f(\alpha) \right| = \frac{(\beta - \alpha)^2}{2} \sup_{x \in [\alpha, \beta]} |f'(x)|. \quad (3.28)$$

We can use this estimation on the intervals composing  $B$ , or rather if for all  $B_i$  (3.28) holds, and remind that  $m(B_i) = \Delta x$

$$\left| \sum_{i=0}^{n-m} f_i B_i - \int_B f(x) dx \right| \leq \sum_{i=0}^{n-m} \frac{(\Delta x)^2}{2} \sup_{x \in B_i} |f'(x)| \leq m(B) \frac{\Delta x}{2} \sup_{x \in B} |f'(x)|. \quad (3.29)$$

Where  $m(B)$  is the measure of the set  $B$  ( $m(B) \leq |b - a|$ ). Focus, now, on the integration domain  $\Gamma$ . For this, we make the worst estimation that is possible, i.e., for the boundness of  $f$ ,

$$\left| \sum_{i=0}^m f_i C_i - \int_{\Gamma} f(x) dx \right| \leq \sum_{i=0}^m 2M \Delta x \leq 2M m \Delta x \quad (3.30)$$

We can conclude obtaining the equation (3.24) placing  $C = \frac{|b-a|}{2} \sup_{x \in B} |f'(x)| + 2Mm$ . We note that  $\sup_{x \in B} |f'(x)|$  is bounded for Weierstrass' theorem ( $f \in C^1$  on a compact set).  $\square$

We want to give an approximation of  $V_m$ .

We have to add some hypothesis on the discontinuous function  $f$ . We suppose

- $|f(x)| < M$  for some  $M > 0$ .
- we can find a partition of  $\Omega = \bigcup_i \Omega_i$  with  $\bigcap_i \Omega_i = \emptyset$ , such that  $f \in C^{0,1}(\Omega_i)$ .

We proceed to a semidiscretization on the time variable on the dynamics associated to the optimization problem. We define  $h > 0$  the discretization step and we call, in the usual way,  $t_j = j \cdot h$  with  $j \in \mathbb{N}$ , we call furthermore,  $\alpha = \{a_j = a(t_j) \in \mathcal{A}, j \in \mathbb{N}\}$  e  $y_j = y(t_j)$ . Obviously  $a_j \in A$  for any  $j \in \mathbb{N}$ . Therefore the dynamic, discretized, will be:

$$\begin{cases} y_{j+1} = y_j + hb(y_j, a_j) \\ y_0 = x \end{cases} \quad (3.31)$$

we also link to this dynamic a cost functional, a discretization of the optimization problem of which  $V_m$  is the value function

$$J(x, \alpha) = h \sum_{j=0}^n e^{-\lambda h j} [g(y_j, a_j) + f_*(y_j)] + e^{-\lambda h(n+1)} \psi(y_k) \quad (3.32)$$

where  $(n+1) = \inf\{i \in \mathbb{N} : y_i \notin \Omega\}$  and  $\tau_x = (n+1)h$ .

Therefore the approximation of the value function of this problem, that is a discretization of  $V_m(x)$  will be

$$V_h(x) = h \inf_{a \in \mathcal{A}} \sum_{j=0}^n \left( \frac{1}{1 + \lambda h} \right)^j [g(y_j, a_j) + f_*(y_j)] + \left( \frac{1}{1 + \lambda h} \right)^{n+1} \psi(y_{n+1}) \quad (3.33)$$

where  $\{y_j; j \in \{0, 1, \dots, n+1\}\}$  is a discretization of the trajectory that follow (3.31).

**Proposition 3.4.** *We have that*

$$\|V_h(x) - V_m(x)\|_{L^1} \leq Ch \quad (3.34)$$

*Proof.* Let fix a  $x \in \Omega$ , and chose a control  $\bar{a}$  that minimize  $V_m(x)$ ,

$$\begin{aligned} V_h(x) - V_m(x) &= \\ h \inf_{a \in \mathcal{A}} \sum_{j=0}^n \left( \frac{1}{1 + \lambda h} \right)^j f_*(y_j) + e^{-\lambda h(n+1)} \varphi(y_{n+1}) &- \inf_{a \in \mathcal{A}} \int_0^{\tau_x} e^{-\lambda t} f_*(y_x(t)) + e^{-\lambda \tau_x} \varphi(y_x(\tau_x)) dt \\ &\leq h \sum_{j=0}^n \left( \frac{1}{1 + \lambda h} \right)^j f_*(y_j) - \int_0^{\tau_x} e^{-\lambda t} f_*(y_x(t)) \Delta t \\ &\leq h \sum_{j=0}^n \left( \frac{1}{1 + \lambda h} \right)^j f_*(y_j) - \int_0^{\tau_x} \left( \frac{1}{1 + \lambda h} \right)^{\lfloor \frac{t}{h} \rfloor} f_*(y_x(t)) dt + o(h) \\ &\leq Ch + o(h) \leq C'h \end{aligned} \quad (3.35)$$

where  $\lfloor \frac{t}{n} \rfloor$  is the nearest lower integer to  $\frac{t}{n}$  and  $C, C'$  are positive constants.

We can make the same exchanging the role of the terms. We obtain

$$|V_h(x) - V_m(x)| \leq Ch \quad (3.36)$$

for a  $C > 0$  independent from  $h$ . Finally, using this relation for every point of  $\Omega$

$$\int_{\Omega} |V_h(x) - V_m(x)| dx \leq Chm(\Omega) \quad (3.37)$$

where  $m(\Omega)$  is the measure (finite) of the set  $\Omega$ . □

### 3.3 Fully Discrete Scheme

We consider a uniform discretization of the set  $\Omega_{\Delta x} := \Omega \cap \mathbb{Z}^n \Delta x$ . We introduce also the application

$$T(U)(x_{\alpha}) = \frac{1}{1 + \lambda h} \inf_{a \in A} \{U(x_{\alpha} + hb(x_{\alpha}, a_{\alpha}))\} + hf_*(x_{\alpha}) \quad (3.38)$$

and the space of piecewise linear functions

$$\mathcal{W}_{\Delta x} = \{w : \bar{\Omega} \rightarrow \mathbb{R} \mid w \in C(\Omega) \text{ and } Dw(x) = c_{\alpha} \text{ for any } x \in (x_{\alpha}, a_{\alpha+1})\} \quad (3.39)$$

This application  $T$  is a contraction on the space of the bounded functions with the uniform norm. We mean

**Proposition 3.5.** *Let  $x_{\alpha} - hb(x_{\alpha}, a_{\alpha}) \in \bar{\Omega}$  for every  $x_{\alpha} \in \bar{\Omega}_{\Delta x}$ , for any  $a \in A$ , so there exists a unique solution  $W$  of (3.38) in  $\mathcal{W}_{\Delta x}$ .*

*Proof.* By our assumption, starting from any  $x_{\alpha} \in \bar{\Omega}_{\Delta x}$  we will reach points which still belong to  $\Omega$ . So, for every  $w \in \mathcal{W}_{\Delta x}$  we have

$$w(x_{\alpha} - ab(x_{\alpha}, a_{\alpha})) = \sum_{j=1}^L \lambda_{\alpha j}(a) w(x_j)$$

where  $\lambda_{\alpha j}(a)$  are the coefficients of the convex combination representing the point  $x_{\alpha} - ab(x_{\alpha}, a_{\alpha})$ , and  $L$  the number of nodes of  $\bar{\Omega}_{\Delta x}$ , i.e.

$$x_{\alpha} - ab(x_{\alpha}, a_{\alpha}) = \sum_{j=1}^L \lambda_{\alpha j}(a) x_j \quad (3.40)$$

now we observe

$$0 \leq \lambda_{\alpha j}(a) \leq 1 \quad \text{and} \quad \sum_{j=1}^L \lambda_{\alpha j}(a) = 1 \quad \text{for any } a \in B(0, 1) \quad (3.41)$$

We can rewrite (3.38) as the following fixed point problem in finite dimension

$$W = S(W)$$

where the map  $S : \mathbb{R}^L \rightarrow \mathbb{R}^L$  is defined componentwise as

$$(S(W))_\alpha := \left[ \frac{1}{1 + \lambda h} \min_{a \in B(0,1)} \Lambda(a)W + hf_*(x_\alpha) \right]_\alpha \quad \alpha \in 1, \dots, L$$

$W_\alpha \equiv W(x_\alpha)$  and  $\Lambda(a)$  is the  $L \times L$  matrix of the coefficients  $\lambda_{\alpha j}$  satisfying (3.40), (3.41) for  $\alpha, j \in 1, \dots, L$ .

$S$  is a contraction mapping for  $\lambda > 0$ . In fact, let  $\bar{a}$  be a control giving the minimum in  $S(V)_\alpha$ , we have

$$\begin{aligned} [S(W) - S(V)]_\alpha &\leq \frac{1}{1 + \lambda h} [\Lambda(\bar{a})(W - V)]_\alpha \\ &\leq \frac{1}{1 + \lambda h} \max_{\alpha, j} |\lambda_{\alpha j}(a)| \|W - V\|_\infty \leq \frac{1}{1 + \lambda h} \|W - V\|_\infty \end{aligned}$$

Switching the role of  $W$  and  $V$  we can conclude that

$$\|S(W) - S(V)\|_\infty \leq \frac{1}{1 + \lambda h} \|W - V\|_\infty$$

□

We want show now, that the restriction of  $V_h|_{\bar{\Omega}_{\Delta x}} \subset \mathcal{W}_{\Delta x}$  is equal to  $W$ , fixed point of the application  $T$ .

**Proposition 3.6.** *The function*

$$W(x) := \begin{cases} h \inf_{a \in \mathcal{A}} \sum_{j=0}^n \left( \frac{1}{1 + \lambda h} \right)^j [g(y_j, a_j) + f_*(y_j)] + \left( \frac{1}{1 + \lambda h} \right)^{n+1} \psi(y_{n+1}), & \text{if } x \in \Omega_{\Delta x} \\ \gamma x_\alpha + (1 - \gamma)x_{\alpha+1} & \text{if } x \notin \Omega_{\Delta x} \text{ and } x \in [x_\alpha, x_{\alpha+1}] \end{cases} \quad (3.42)$$

is the unique fixed point of the application  $T$ .

*Proof.* We substitute on (3.38) the function (3.42) on a point  $x_\alpha \in \Omega_{\Delta x}$ .

We call  $y_0 := x_\alpha$ ,

$$\begin{aligned} h \sum_{j=0}^n \left( \frac{1}{1 + \lambda h} \right)^j f_*(y_j) + e^{-\lambda h(n+1)} \psi(y_{n+1}) \\ = \frac{h}{1 + \lambda h} \sum_{j=0}^{n-1} \left( \frac{1}{1 + \lambda h} \right)^j f_*(y_{j+1}) + hf_*(y_0) + e^{-\lambda h(n+1)} \psi(y_{n+1}) \end{aligned} \quad (3.43)$$

we make the substitution  $i = j + 1$  on the right hand term, getting

$$h \sum_{j=1}^n \left( \frac{1}{1 + \lambda h} \right)^j f_*(y_j) + h f_*(y_0) = h \sum_{i=1}^n \left( \frac{1}{1 + \lambda h} \right)^i f_*(y_i) + h f_*(y_0) \quad (3.44)$$

so we have shown the assumption.  $\square$

We have now to show that  $W \in \mathcal{W}_{\Delta x}$  is sufficiently near to  $V_h(x)$ .

*Proof.* We start considering the following

$$\int_{\Omega} |W(x) - V_h(x)| dx \leq \frac{m(\Omega)}{m(e(x_\alpha))} \max_{e_\beta} \int_{e_\beta} |W(x_\beta) - V_h(x_\beta)| dx \quad (3.45)$$

where  $e_\beta$  is a finite element of the lattice  $\Omega_{\Delta x}$  and  $x_\beta \in e_\beta$ .

We have that  $x_\beta \notin \Omega_{\Delta x}$ , otherwise we have  $|W(x_\beta) - V_h(x_\beta)| = 0$ . So  $x_\beta \notin \Omega_{\Delta x}$ . To fix our ideas we restrict ourselves in dimension 1.

We impose  $\tilde{y}_0 = x_\alpha$ ,  $\bar{y}_0 = x_\alpha + 1$  and  $\hat{y}_0 = x_\beta$  with  $x_\alpha < x_\beta < x_{\alpha+1}$ . We have

$$\begin{aligned} |W(x) - V_h(x)| &= \left| h\gamma \inf_{a \in A} \sum_{j=0}^n \left( \frac{1}{1 + \lambda h} \right)^j f_*(\tilde{y}_j) \right. \\ &\quad \left. + (1 - \gamma)h \inf_{a \in A} \sum_{j=0}^n \left( \frac{1}{1 + \lambda h} \right)^j f_*(\bar{y}_j) - h \inf_{a \in A} \sum_{j=0}^n \left( \frac{1}{1 + \lambda h} \right)^j f_*(\hat{y}_j) \right| \\ &\leq h \left| \sum_{j=0}^n \left( \frac{1}{1 + \lambda h} \right)^j (\gamma f_*(\tilde{y}_j) + (1 - \gamma)f_*(\bar{y}_j)) - f_*(\hat{y}_j) \right| \\ &\leq h \sum_{j=0}^n \left( \frac{1}{1 + \lambda h} \right)^j |(\gamma f_*(\tilde{y}_j) + (1 - \gamma)f_*(\bar{y}_j)) - f_*(\hat{y}_j)| \\ &\leq h \sum_{j=0}^n \left( \frac{1}{1 + \lambda h} \right)^j 2m. \end{aligned} \quad (3.46)$$

So, coming back to the (3.45) we have

$$\int_{\Omega} |W(x) - V_h(x)| dx = \frac{b-a}{\Delta x} \Delta x h \sum_{j=0}^n \left( \frac{1}{1 + \lambda h} \right)^j 2m \leq Ch \quad (3.47)$$

$\square$

Finally, we can prove that

$$\|W(x) - V_m(x)\|_{L^1} \leq \|W(x) - V_h(x)\|_{L^1} + \|V_h(x) - V_m(x)\|_{L^1} \leq Ch \quad (3.48)$$

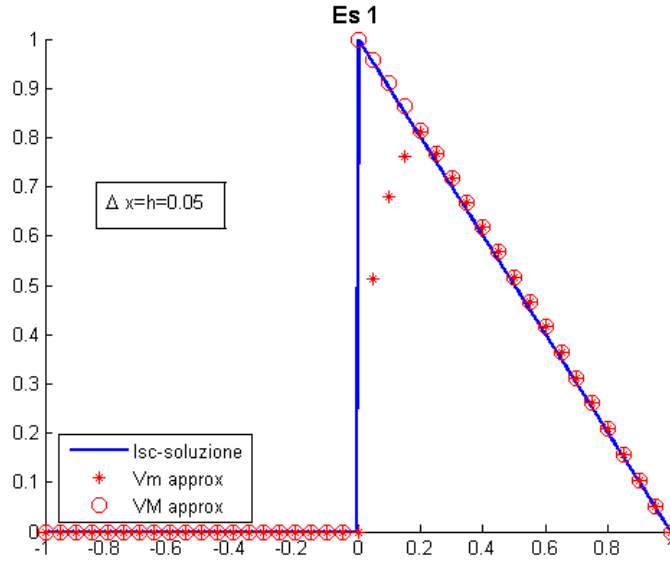

Figure 3.1: Esemplio 1.

### 3.4 Examples and Tests

#### Example 1

We want to solve the following equation on the interval  $[-1, 1]$

$$u + |xu'| = f(x) \quad (3.49)$$

with

$$f(x) := \begin{cases} 1 & x > 0 \\ 0 & x \leq 0 \end{cases} \quad (3.50)$$

hence we have, for the symbology that we have chosen, that  $\lambda = 1$ ,  $b(x, a) = -ax$  and  $g(x, a) = 0$ . The solutions of the dynamic, in this case are very simple, that is they are  $y(t) = xe^{-at}$ .

Let explicitly calculate the functions  $V_m$  and  $V_M$ . We have

$$V_m(x) = \inf_{a \in \mathcal{A}} \int_0^{\tau_x(a)} e^{-t} f_*(y(t, a)) dt = \begin{cases} \int_0^{\ln -x^{-1}} 0 dt = 0 & x \leq 0 \\ \int_0^{\ln x^{-1}} e^{-t} dt = [-e^{-t}]_0^{\ln x^{-1}} = 1 - x & x > 0 \end{cases} \quad (3.51)$$

It's simple showing, in fact, with the same reckoning, that  $V_m(x) = V_M(x)$  for  $x \in \bar{\Omega} \setminus \{0\}$ . The functions will diverge only in  $x = 0$  where  $V_m(0) = 0 \neq 1 = V_M(0)$ , it's sufficient to think that  $V_m$  is l.s.c. and  $V_M$  is u.s.c.

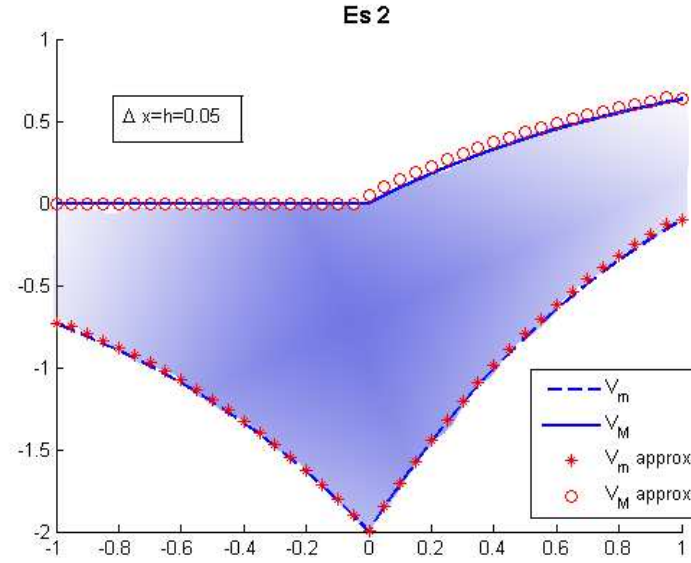
Figure 3.2: Example 2.  $c = 2$ .

Therefore, in this case we have not the uniqueness for viscosity solutions, instead

$$V_m(x) = (V_M)_*(x) = \begin{cases} 0 & x \leq 0 \\ 1 - x & x > 0 \end{cases} \quad (3.52)$$

it is our unique lsc-solution.

We want to verify if the numerical approximation introduced in the previous section, converges to the right solution. Let make a test obtaining the results contained in Figure 3.1 and in Table 3.4, where it is reported experimental errors of the approximation of  $V_m$ .

$V_m approx \Delta x = h$	$\ \cdot\ _\infty$	$Ord(L_\infty)$	$\ \cdot\ _1$	$Ord(L^1)$
<b>0.4</b>	0.5302		0.1827	
<b>0.2</b>	0.9960	-0.9096	0.1729	0.0795
<b>0.1</b>	0.9935	0.0036	0.1166	0.5684
<b>0.05</b>	0.9885	0.0073	0.0765	0.6080
<b>0.025</b>	0.9785	0.0147	0.0495	0.6280
<b>0.0125</b>	0.9585	0.0298	0.0349	0.5042

### Example 2

Let consider, now, the equation on  $[-\infty, +\infty]$

$$u + |u'| = f(x) \quad (3.53)$$

con

$$f(x) := \begin{cases} 0 & x < 0 \\ -c & x = 0 \\ 1 & x > 0 \end{cases} \quad (3.54)$$

so  $\lambda = 1$ ,  $b(x, a) = -a$  and  $g(x, a) = 0$ . In this case the solutions of the dynamics are:  $y(t) = -at + x$ . Let find explicitly, also in this case, the functions  $V_m$  and  $V_M$ . Let note that  $f_* \equiv f$  while  $f^*$  diverges from  $g$  only in  $x = 0$  where  $f^*(0) = 1$ . We have

$$V_m(x) = \inf_{a \in \mathcal{A}} \int_0^{+\infty} e^{-t} f_*(y(t, a)) dt = \begin{cases} \int_0^x 0 dt + \int_x^{+\infty} -ce^{-t} dt = \lim_{s \rightarrow +\infty} [ce^{-t}]_x^s = -ce^x & x \leq 0 \\ \int_0^x e^{-t} dt + \int_x^{+\infty} -ce^{-t} dt = 1 - e^{-x}(1 + c) & x > 0 \end{cases} \quad (3.55)$$

while for what concern  $V_M$

$$V_M(x) = \inf_{a \in \mathcal{A}} \int_0^{+\infty} e^{-t} f^*(y(t, a)) dt = \begin{cases} \int_0^x 0 dt = 0 & x < 0 \\ \int_0^x e^{-t} dt + \int_x^{+\infty} 0 e^{-t} dt = 1 - e^{-x} & x \geq 0 \end{cases} \quad (3.56)$$

Hence, in this case, we have no uniqueness of solutions. Viscosity solutions or lsc-solutions are contained between  $V_m$  and  $V_M$ . That is, called  $U$  a solution  $V_m(x) \leq U \leq V_M(x)$ .

Also in this case, we make a numerical test performing the scheme for  $V_m$  and  $V_M$ . The results are presented in Figure 3.2.

### Example 3

Let pass on a higher dimension. Let take  $\Omega = ]0, 1[ \times ]0, 1[ ((x, y) \in \Omega)$  and consider the Dirichlet problem

$$\begin{aligned} -u_x &= f(x, y) & (x, y) \in \Omega \\ u(x, y) &= 0 & (x, y) \in \partial\Omega \end{aligned} \quad (3.57)$$

with

$$f(x) := \begin{cases} 0 & y > \frac{1}{2} \\ 1 & otherwise \end{cases} \quad (3.58)$$

so  $\lambda = 1$ ,  $b(x, y, a) \equiv (0, 1)$  e  $g(x, a) = 0$ . In this case we can immediately deduce that for  $y \neq \frac{1}{2}$ ,

$$V_m(x, y) = V_M(x, y) = \begin{cases} 1 - x & y < \frac{1}{2} \\ 0 & y > \frac{1}{2} \end{cases} \quad (3.59)$$

We have that  $V_m$  is lower semicontinuous and  $V_M$  is upper semicontinuous, instead. The two solutions will diverge for  $y = \frac{1}{2}$ . This case is very similar to the 1-D one, presented on the example 1. We will have the uniqueness for the lsc-solution for the boundary value problem, from the fact that  $V_m = (V_M)_*$ . We remark that the boundary condition is not attained on every point but only in a generalized sense.

Also in this case, we make a numerical test performing the scheme for  $V_m$  and  $V_M$ . The results are presented in Figure 3.3.



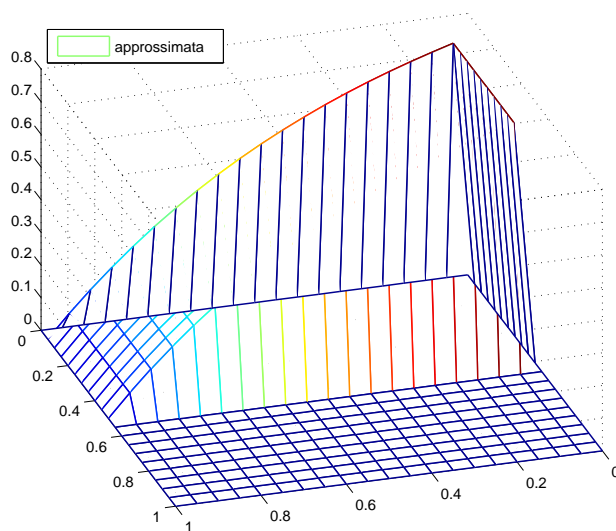

Figure 3.3: Example 3.



## Chapter 4

# Eikonal equation on Networks

Several phenomena in physics, chemistry and biology, described by interaction of different media, can be translated into mathematical problems involving differential equations which are not defined on connected manifold as usual, but instead on so-called ramified spaces. The latter can be roughly visualized as a collection of different manifolds of the same dimension (branches) with certain parts of their boundaries identified (ramification space). The simplest examples of ramified spaces are *topological networks*, which basically are graphs embedded in Euclidean space. The iteration among the collection of differential equation describing the behavior of physical quantities on the branches is described by certain transition conditions governing the interaction of the quantities across the ramification spaces.

We can also view this problem, as a particular case of state constraint, becoming, in some cases, an alternative approach to the well-known theory of Hamilton-Jacobi theory with state constraints, developed by several authors like P.L. Lions, H. Ishii, I. Capuzzo Dolcetta et al. and still an open field of research.

In this chapter we will consider an Eikonal equation on a topological network. This situation can be viewed as a minimum time problem, solved on a irregular domain (a graph on  $\mathbb{R}^n$ ), with a general continuous running cost  $f(x)$ . This problem is strictly related to detect shortest paths connecting the vertices of a weighted graph  $\Gamma$  to prescribed target set of vertices. This is a very famous problem, typically solved with combinatoric techniques. Dijkstra's classical algorithm [20] was the first managing the situation where there is exactly one target vertex (single-source shortest path problem), and it is followed by a long list of modifications or more specific approaches to the same problem (see for instance [31], [56]).

Dijkstra's algorithm successively lists all shortest paths from the target to the other vertices: starting at the target vertex  $v_0$ , it determines the level sets  $L_t := \{x \in \Gamma \mid d(x) = t\}$  of the distance from the target for continuously increasing  $t \geq 0$ . As soon as a set  $L_t$  contains one or more vertices, these vertices are assigned the shortest distance  $t$  to the target, along with the way "back downhill" as shortest path to the target (which is not necessarily unique). This procedure is continued until a shortest path is assigned to each vertex.

Whereas Dijkstra's algorithm is originally restricted to abstract weighted graphs (that is, detection of shortest ways between vertices), the level set idea described here may of course be extended to all points of the graph, particularly to edge points. Moreover the weights can be assumed to vary in a continuous way along the edges (continuous shortest path problem). In this case the problem cannot be solved by means of algorithms of combinatoric type and a different approach is compulsory.

In  $\mathbb{R}^N$  the problem of finding the (weighted) distance to a given target set  $\mathcal{T}$  is equivalent to solve the Eikonal equation  $|Du| = f(x)$  in  $\mathbb{R}^N \setminus \mathcal{T}$  with a null Dirichlet boundary condition on the target set  $\mathcal{T}$ . This problem was presented in chapter 1.

To solve the continuous shortest path problem we aim to study Eikonal equations on graphs. In [51] a notion of viscosity solution for Hamilton-Jacobi equations of Eikonal type on graphs is introduced. It has been proved that this notion satisfies a comparison principle giving uniqueness. Existence has been proved via a representation formula for the solution of the Dirichlet problem. It is worthwhile to observe that the previous approach is intrinsically 1-dimensional, since Hamilton-Jacobi equations and differentiation along the edges are given in an intrinsic way making use of the maps embedding the network in  $\mathbb{R}^N$ . The crucial point is obviously the definition of viscosity solution at the vertices which allows to select the correct a.e. solution, i.e. the distance function from the target set.

In this chapter we will firstly present (section 4.2) some theoretical results contained in [51] where the authors introduce a concept of viscosity solution on a network and discuss the well-posedness. The rest of the chapter is concerning original numerical results. In the following section (section 4.3) we introduce a scheme of semiLagrangian type by discretizing with respect to the time the representation formula for the solution of the Dirichlet problem. The proof of the convergence of the scheme relies on stability properties of the viscosity solution given in [51] and it can be easily modified to manage other boundary conditions instead of Dirichlet one or, also, different approximation schemes. We will also study a fully discrete scheme giving a finite-dimensional problem which can be solved in practice. The scheme is obtained via a finite element discretization of the discrete in time problem. Also for this step of the discretization procedure we prove convergence of the scheme to the unique solution of the continuous problem. It is important to observe that the scheme not only computes the solution of the Eikonal equations, but it also produces an approximation of the shortest paths to the target set.

In section 4.4 We also discuss some issues concerning the implementation of the algorithm and we present some numerical examples. The original elements of this chapter (sections 4.3,4.4) are also presented in the paper [15] by Camilli, Festa and Schieborn.

## 4.1 Introduction

The concept of ramified spaces has originally been introduced by Lumer [43] and has later been refined and specified by various authors, e.g., J. von Below and S. Nicaise [46]. Since 1980, many results have been published treating different kinds of interaction problems involving linear and quasi-linear differential equations (confer for instance with Lagnese and Leugering [38], Lagnese,

Leugering and Schmidt [39], von Below and Nicaise [11]).

As far as we know, fully nonlinear equations such as Hamilton-Jacobi equations have not yet been examined to a similar extent on ramified spaces. The major difficulty, to extend the concept of viscosity solutions to topological networks is to establish a correct transition condition at transition vertices. As a matter of fact, these transition conditions make up the core of this theory, as they constitute the major difference from the classical theory of viscosity solutions.

A different attempt to study Hamilton-Jacobi equations on networks has already been made in [1]. However, the aim of this paper deviates from the one addressed in the present paper: its main issue is to characterize the value function of controlled dynamics in  $\mathbb{R}^2$  restricted to a network. Therefore, the choice of the Hamiltonian, which may be discontinuous with respect to the state variable, has to be restricted by assumptions ensuring both a suitable continuity property with respect to the state variable and the fact that the set of admissible controls be not empty at any point of the network. Additionally, the definition of viscosity solution characterizing the value function is different from this approach, as it involves directional derivatives of test functions in  $\mathbb{R}^2$  along the edges.

In the present chapter, Hamilton-Jacobi equations and differentiation along the edges are given in an intrinsic way making use of the maps embedding the network in  $\mathbb{R}^n$ , hence the approach is intrinsically 1-dimensional. Moreover in our approach appropriate assumptions at the transition vertices guarantee the continuity of the Hamiltonian with respect to the state variable. The existence of a viscosity solution is obtained by a representation formula involving a distance associated to the Hamiltonian (see [17, 28, 36] for corresponding results on connected domains), the solution turning out to be the maximal subsolution of the problem. Uniqueness, on the other hand, relies on a comparison principle inspired by Ishii's classical argument for Eikonal equations [34]. In this respect, the existence of a strict subsolution plays a key role. An important and classical problem in graph theory is the shortest path problem, i.e. the problem of computing in a weighted graph the distance of the vertices from a given target vertex ([9]). The weights represent the cost of running through the edges. A motivation of our work is to generalize the previous problem to the case of a running cost which varies in a continuous way along the edges. In this case the aim is to compute the distance of any point of the graph from a given target set and this in practice corresponds to solve the Eikonal equation  $|Du| = f(x)$  on the network with a zero-boundary condition on the target vertices. Moreover Hamilton-Jacobi equations of Eikonal type are important in several fields, for example geometric optics [10], homogenization [22], singular perturbation [2], weak KAM theory [23, 24], large-time behavior [35], and mean field games theory [40].

## 4.2 Assumptions and preliminary results

We give the definition of graph suitable for our problem. We will also use the equivalent terminology of topological network (see [43]).

**Definition 4.1.** *Let  $V = \{v_i, i \in I\}$  be a finite collection of different points in  $\mathbb{R}^N$  and let*

$\{\pi_j, j \in J\}$  be a finite collection of differentiable, non self-intersecting curves in  $\mathbb{R}^N$  given by

$$\pi_j : [0, l_j] \rightarrow \mathbb{R}^N, l_j > 0, j \in J.$$

Set  $e_j := \pi_j((0, l_j))$ ,  $\bar{e}_j := \pi_j([0, l_j])$ , and  $E := \{e_j : j \in J\}$ . Furthermore assume that

- i)  $\pi_j(0), \pi_j(l_j) \in V$  for all  $j \in J$ ,
- ii)  $\#(\bar{e}_j \cap V) = 2$  for all  $j \in J$ ,
- iii)  $\bar{e}_j \cap \bar{e}_k \subset V$ , and  $\#(\bar{e}_j \cap \bar{e}_k) \leq 1$  for all  $j, k \in J, j \neq k$ .
- iv) For all  $v, w \in V$  there is a path with end-points  $v$  and  $w$  (i.e. a sequence of edges  $\{e_j\}_{j=1}^N$  such that  $\#(\bar{e}_j \cap \bar{e}_{j+1}) = 1$  and  $v \in \bar{e}_1, w \in \bar{e}_N$ ).

Then  $\bar{\Gamma} := \bigcup_{j \in J} \bar{e}_j \subset \mathbb{R}^N$  is called a (finite) topological network in  $\mathbb{R}^N$ .

For  $i \in I$  we set  $Inc_i := \{j \in J : e_j \text{ is incident to } v_i\}$ . Given a nonempty set  $I_B \subset I$ , we define  $\partial\Gamma := \{v_i, i \in I_B\}$  and we set  $I_T := I \setminus I_B$ . We also set  $\Gamma := \bar{\Gamma} \setminus \partial\Gamma$ . We always assume  $i \in I_B$  whenever  $\#(Inc_i) = 1$  for some  $i \in I$ .

For any function  $u : \bar{\Gamma} \rightarrow \mathbb{R}$  and each  $j \in J$  we denote by  $u^j$  the restriction of  $u$  to  $\bar{e}_j$ , i.e.

$$u^j := u \circ \pi_j : [0, l_j] \rightarrow \mathbb{R}.$$

We say that  $u$  is continuous in  $\bar{\Gamma}$  and write  $u \in C(\bar{\Gamma})$  if  $u$  is continuous with respect to the subspace topology of  $\bar{\Gamma}$ . This means that  $u^j \in C([0, l_j])$  for any  $j \in J$  and

$$u^j(\pi_j^{-1}(v_i)) = u^k(\pi_k^{-1}(v_i)) \quad \text{for any } i \in I, j, k \in Inc_i.$$

We define differentiation along an edge  $e_j$  by

$$\partial_j u(x) := \partial_j u^j(\pi_j^{-1}(x)) = \frac{\partial}{\partial x} u^j(\pi_j^{-1}(x)), \quad \text{for } x \in e_j,$$

and at a vertex  $v_i$  by

$$\partial_j u(x) := \partial_j u^j(\pi_j^{-1}(x)) = \frac{\partial}{\partial x} u^j(\pi_j^{-1}(x)) \quad \text{for } x = v_i, j \in Inc_i.$$

Observe that the parametrization of the arcs  $e_j$  induces an orientation on the edges, which can be expressed by the signed incidence matrix  $A = \{a_{ij}\}_{i,j \in J}$  with

$$a_{ij} := \begin{cases} 1 & \text{if } v_i \in \bar{e}_j \text{ and } \pi_j(0) = v_i, \\ -1 & \text{if } v_i \in \bar{e}_j \text{ and } \pi_j(l_j) = v_i, \\ 0 & \text{otherwise.} \end{cases} \quad (4.1)$$

**Definition 4.2.** Let  $\varphi \in C(\Gamma)$ .

- i) Let  $x \in e_j, j \in J$ . We say that  $\varphi$  is differentiable at  $x$ , if  $\varphi^j$  is differentiable at  $\pi_j^{-1}(x)$ .

ii) Let  $x = v_i$ ,  $i \in I_T$ ,  $j, k \in \text{Inc}_i$ ,  $j \neq k$ . We say that  $\varphi$  is  $(j, k)$ -differentiable at  $x$ , if

$$a_{ij}\partial_j\varphi_j(\pi_j^{-1}(x)) + a_{ik}\partial_k\varphi_k(\pi_k^{-1}(x)) = 0, \quad (4.2)$$

where  $(a_{ij})$  as in (4.1).

**Remark 4.1.** Condition (4.2) demands that the derivatives in the direction of the incident edges  $j$  and  $k$  at the vertex  $v_i$  coincide, taking into account the orientation of the edges.

We consider the eikonal equation

$$|\partial u| - f(x) = 0, \quad x \in \Gamma. \quad (4.3)$$

where  $f \in C^0(\bar{\Gamma})$ , i.e.  $f(x) = f^j(\pi_j^{-1}(x))$  for  $x \in \bar{e}_j$ ,  $f^j \in C^0([0, l_j])$ ,  $f^j(\pi_j^{-1}(v_i)) = f^k(\pi_k^{-1}(v_i))$  for any  $i \in I$ ,  $j, k \in \text{Inc}_i$ . Moreover we assume that

$$f(x) \geq \eta > 0 \quad x \in \Gamma \quad (4.4)$$

**Definition 4.3.**

A function  $u \in \text{USC}(\bar{\Gamma})$  is called a (viscosity) subsolution of (4.3) in  $\Gamma$  if the following holds:

i) For any  $x \in e_j$ ,  $j \in J$ , and for any  $\varphi \in C(\Gamma)$  which is differentiable at  $x$  and for which  $u - \varphi$  attains a local maximum at  $x$ , we have

$$|\partial_j\varphi(x)| - f(x) := |\partial_j\varphi_j(\pi_j^{-1}(x))| - f^j(\pi_j^{-1}(x)) \leq 0.$$

ii) For any  $x = v_i$ ,  $i \in I_T$ , and for any  $\varphi$  which is  $(j, k)$ -differentiable at  $x$  and for which  $u - \varphi$  attains a local maximum at  $x$ , we have

$$|\partial_j\varphi(x)| - f(x) \leq 0.$$

A function  $u \in \text{LSC}(\bar{\Gamma})$  is called a (viscosity) supersolution of (4.3) in  $\Gamma$  if the following holds:

i) For any  $x \in e_j$ ,  $j \in J$ , and for any  $\varphi \in C(\Gamma)$  which is differentiable at  $x$  and for which  $u - \varphi$  attains a local minimum at  $x$ , we have

$$|\partial_j\varphi(x)| - f(x) \geq 0.$$

ii) For any  $x = v_i$ ,  $i \in I_T$ ,  $j \in \text{Inc}_i$ , there exists  $k \in \text{Inc}_i$ ,  $k \neq j$ , (which we will call  $i$ -feasible for  $j$  at  $x$ ) such that for any  $\varphi \in C(\Gamma)$  which is  $(j, k)$ -differentiable at  $x$  and for which  $u - \varphi$  attains a local minimum at  $x$ , we have

$$|\partial_j\varphi(x)| - f(x) \geq 0.$$

A continuous function  $u \in C(\Gamma)$  is called a (viscosity) solution of (4.3) if it is both a viscosity subsolution and a viscosity supersolution.

**Remark 4.2.** Let  $i \in I_T$  and  $\varphi \in C(\Gamma)$  be  $(j, k)$ -differentiable at  $x = v_i$ . Then

$$\begin{aligned} |\partial_j \varphi(x)| - f(x) &= |\partial_j \varphi_j(\pi_j^{-1}(x))| - f^j(\pi_j^{-1}(x)) = |\pm \partial_j \varphi_k(\pi_k^{-1}(x))| - f^k(\pi_k^{-1}(x)) \\ &= |\partial_k \varphi(x)| - f(x), \end{aligned}$$

hence in the subsolution and supersolution condition at the vertices, it is indifferent to require the condition for  $j$  or for  $k$ .

We give a representation formula for the solution of (4.3) completed with the Dirichlet boundary condition

$$u(x) = g(x) \quad x \in \partial\Gamma \quad (4.5)$$

We define a distance-like function  $S : \bar{\Gamma} \times \bar{\Gamma} \rightarrow [0, \infty)$  by

$$S(x, y) := \inf \left\{ \int_0^t f(\gamma(s)) ds : t > 0, \gamma \in B_{x,y}^t \right\} \quad (4.6)$$

where

- i)  $\gamma : [0, t] \rightarrow \Gamma$  is a piecewise differentiable path in the sense that there are  $t_0 := 0 < t_1 < \dots < t_{n+1} := t$  such that for any  $m = 0, \dots, n$ , we have  $\gamma([t_m, t_{m+1}]) \subset \bar{e}_{j_m}$  for some  $j_m \in J$ ,  $\pi_{j_m}^{-1} \circ \gamma \in C^1(t_m, t_{m+1})$ , and

$$|\dot{\gamma}(s)| = \left| \frac{d}{ds} (\pi_{j_m}^{-1} \circ \gamma)(s) \right| = 1.$$

- ii)  $B_{x,y}^t$  is the set of all such paths with  $\gamma(0) = x$ ,  $\gamma(t) = y$ .

If  $f(x) \equiv 1$ , then  $S(x, y)$  coincides with the path distance  $d(x, y)$  on the graph, i.e. the distance given by the length of shortest arc in  $\bar{\Gamma}$  connecting  $y$  to  $x$ . The following result is in the spirit of the corresponding results in  $\mathbb{R}^N$  in [17], [28], [36] (for the proof, see [51, Proposition 6.1])

**Theorem 4.1.** Let  $g : \bar{\Gamma} \rightarrow \mathbb{R}$  be a continuous function satisfying

$$g(x) - g(y) \leq S(y, x) \quad \text{for any } x, y \in \partial\Gamma. \quad (4.7)$$

Then the unique viscosity solution of (4.3)–(4.5) is given by

$$u(x) := \min\{g(y) + S(y, x) : y \in \partial\Gamma\}. \quad (4.8)$$

**Remark 4.3.** It is worthwhile to observe that if supersolutions were defined similarly to subsolutions, then the supersolution condition could not be satisfied by (4.8). Consider the network  $\Gamma = \cup_{i=1}^3 e_i \subset \mathbb{R}^2$ , where  $e_1 = \{0\} \times [0, 1/2]$ ,  $e_2 = \{0\} \times [-1, 0]$ ,  $e_3 = [0, 1] \times \{0\}$ . and the equation  $|\partial u| - 1 = 0$  with zero boundary conditions at the vertices  $v_1 = (0, 1/2)$ ,  $v_2 = (0, -1)$ ,  $v_3 = (1, 0)$ . Then the distance solution, see Theorem 4.1, is given by  $u(x) = \inf\{d(y, x) : y \in \partial\Gamma\}$  where  $d$  is the path distance on the network. The restriction of  $u$  to  $e_2 \cup e_3$  has a local minimum at the vertex  $v_0 = (0, 0)$ . Hence if  $\varphi$  is a constant function,  $u - \varphi$  has a local minimum at  $v_0$  and therefore the supersolution condition is not satisfied for the couple  $(e_2, e_3)$  (see figure 4.1). Instead the arc  $e_1$  is  $v_0$ -feasible, see the definition of supersolution, for both the arcs  $e_2$  and  $e_3$ .



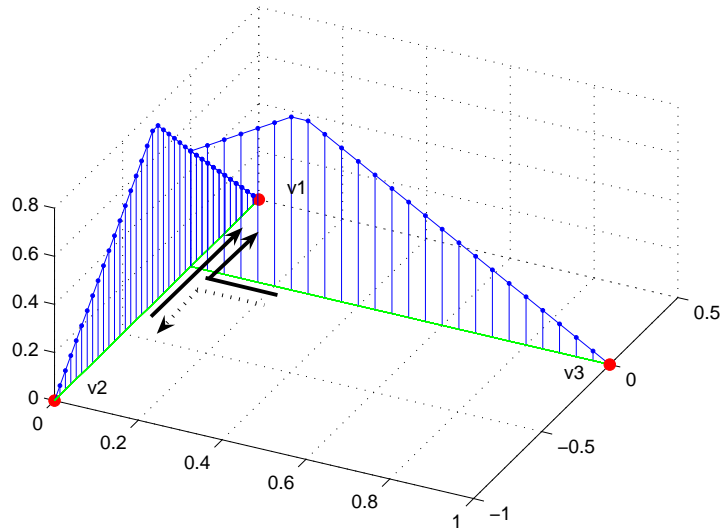

Figure 4.1: Remark 4.3, solid arrows, supersolution condition verified, dashed arrows supersolution condition not verified.

### 4.3 The approximation scheme

We consider an approximation scheme of semiLagrangian type for the problem (4.3)–(4.5).

#### 4.3.1 Semi-discretization in time

Following the approach of [25] we construct an approximation scheme for the equation (4.3) by discretizing the representation formula (4.8). We fix a discretization step  $h > 0$  and we define a function  $u_h : \bar{\Gamma} \rightarrow \mathbb{R}$  by

$$u_h(x) = \inf \{ \mathcal{F}_h(\gamma^h) + g(y) : \gamma^h \in B_{x,y}^h, y \in \partial\Gamma \} \quad (4.9)$$

where  $\mathcal{F}_h(\gamma^h) = \sum_{m=0}^M h f(\gamma_m^h) |q_m|$  and

- i) An admissible trajectory  $\gamma^h = \{\gamma_m^h\}_{m=1}^M \subset \Gamma$  is a finite number of points  $\gamma_m^h = \pi_{j_m}(t_m) \in \Gamma$  such that for any  $m = 0, \dots, M$ , the arc  $\widehat{\gamma_m^h \gamma_{m+1}^h} \subset \bar{e}_{j_m}$  for some  $j_m \in J$  and  $|q_m| := \left| \frac{t_{m+1} - t_m}{h} \right| \leq 1$
- ii)  $B_{x,y}^h$  is the set of all such paths with  $\gamma_0^h = x, \gamma_M^h = y$ .

**Remark 4.4.** Given  $\gamma^h \in B_{x,y}^h$ , we define a continuous path, still denoted by  $\gamma^h$ , in  $B_{x,y}$  by setting  $\gamma^h(s) = \pi_{j_m}(t_m + \frac{(s-mh)}{h}(t_{m+1} - t_m))$  for  $s \in [mh, (m+1)h]$  if  $\widehat{\gamma_m^h \gamma_{m+1}^h} \subset \bar{e}_{j_m}$ . Then,

recalling formula (4.8) we approximate

$$\int_0^{Mh} f(\gamma(s))|\dot{\gamma}(s)|ds = \sum_{m=1}^M \int_{(m-1)h}^{mh} f(\gamma(s))|q_m|ds \approx \sum_{m=1}^M hf(\gamma_m^h)|q_m|$$

which shows that (4.9) is an approximation of (4.8). In the continuous case it is always possible to assume by reparametrization that  $|\dot{\gamma}(s)| = 1$ . In the discrete one we consider instead velocities in the interval  $[-1, 1]$ , since otherwise near the vertices the discrete dynamics can move only in one direction.

Let  $\mathcal{B}(\Gamma)$  be the space of the bounded functions on the network. We show that the function  $u_h$  can be characterized as the unique solution of the semi-discrete problem

$$u_h(x) = S(h, x, u_h) \quad (4.10)$$

where the scheme  $S : \mathbb{R}^+ \times \bar{\Gamma} \times \mathcal{B}(\Gamma) \rightarrow \mathbb{R}$  is defined by

$$S(h, x, \varphi) = \inf_{q \in [-1, 1]: x_{hq} \in \bar{e}_j} \{\varphi(x_{hq}) + hf(x)|q|\} \quad \text{if } x = \pi_j(t) \in e_j \quad (4.11)$$

$$S(h, x, \varphi) = \inf_{k \in Inc_i} \left[ \inf_{q \in [-1, 1]: x_{hq} \in \bar{e}_k} \{\varphi(x_{hq}) + hf(x)|q|\} \right] \quad \text{if } x = v_i, i \in I_T \quad (4.12)$$

$$S(h, x, v) = g(x) \quad \text{if } x \in \partial\Gamma \quad (4.13)$$

where, for  $x = \pi_j(t)$ , we define  $x_{hq} := \pi_j(t - hq)$ .

**Proposition 4.1.** *Assume that*

$$g(x) \leq \inf\{\mathcal{F}_h(\gamma) + g(y) : \gamma \in B_{x,y}^h, y \in \partial\Gamma\} \quad \text{for any } x \in \partial\Gamma. \quad (4.14)$$

Then  $u_h$  is the unique solution of (4.10). Moreover  $u_h$  is Lipschitz continuous uniformly in  $h$ , i.e.

$$|u_h(x_1) - u_h(x_2)| \leq Cd(x_1, x_2) \quad \text{for any } x_1, x_2 \in \bar{\Gamma} \quad (4.15)$$

*Proof.* Let  $u_1, u_2$  be two bounded solutions of (4.10) and set  $w_i(x) = 1 - e^{-u_i(x)}$ , for  $i = 1, 2$ . Then  $w_i$  satisfies

$$w_i(x) = \bar{S}(h, x, w_i) \quad (4.16)$$

where

$$\bar{S}(h, x, \varphi) = \inf_{q \in [-1, 1]: x_{hq} \in \bar{e}_j} \{e^{-hf(x)|q|}\varphi(x_{hq}) + 1 - hf(x)|q|\} \quad \text{if } x = \pi_j(t) \in e_j$$

$$\bar{S}(h, x, \varphi) = \inf_{k \in Inc_i} \left[ \inf_{q \in [-1, 1]: x_{hq} \in \bar{e}_k} \{e^{-hf(x)|q|}\varphi(x_{hq}) + 1 - hf(x)|q|\} \right] \quad \text{if } x = v_i, i \in I_T$$

$$\bar{S}(h, x, v) = 1 - e^{-g(x)} \quad \text{if } x \in \partial\Gamma$$

where, for  $x = \pi_j(t)$ ,  $x_{hq} := \pi_j(t - hq)$ . We have

$$\sup_{\Gamma} |\bar{S}(h, x, w_1(x)) - \bar{S}(h, x, w_2(x))| \leq \beta \sup_{\Gamma} |w_1(x) - w_2(x)|$$

with  $\beta = e^{-h\eta} < 1$ , see (4.4). Since  $\bar{S}$  is a contraction, we conclude that for  $h > 0$  there exists at most one bounded solution of (4.16) and therefore of problem (4.10).

Now we show the function  $u_h$  is a bounded solution of (4.11)–(4.13). It is always possible to assume, by adding a constant, that  $g \geq 0$ . It follows that  $u_h \geq 0$ . Moreover it is easy to see that

$$u_h(x) \leq \|f\|_\infty \sup_{x \in \Gamma} d(x, \partial\Gamma) + \sup_{x \in \partial\Gamma} g(x).$$

To show (4.13), observe that we have  $u_h(x) \neq g(x)$  for  $x \in \partial\Gamma$  if and only if there is some  $z \in \partial\Gamma$  such that  $g(x) > g(z) + \mathcal{F}_h(\gamma^h)$  for some  $\gamma^h \in B_{z,x}^h$  which gives a contradiction to (4.14).

We consider (4.11) and we first show the “ $\leq$ ”-inequality. For  $x \in e_j$  and for  $q \in [-1, 1]$  such that  $x_{hq} \in \bar{e}_j$ , let  $y \in \partial\Gamma$  and  $\gamma_1^h \in B_{x_{hq},y}^h$  be  $\epsilon$ -optimal for  $u_h(x_{hq})$ . Define  $\gamma^h = \{\gamma_i^h\}_{i=0}^1$  with  $\gamma_0^h = x$ ,  $\gamma_1^h = x_{hq}$ . Hence  $\gamma_1^h \cup \gamma^h \in B_{x,y}^h$  (with  $x_{hq}$  counted only one time in  $\gamma_1^h \cup \gamma^h$ ) and

$$u_h(x) \leq g(y) + \mathcal{F}_h(\gamma^h \cup \gamma_1^h) \leq g(y) + \mathcal{F}_h(\gamma^h) + hf(x)|q| \leq u_h(x_{hq}) + \epsilon + hf(x)|q|.$$

To show the reverse inequality, assume that for some  $x \in \Gamma$ ,

$$u_h(x) \leq \inf_{q \in [-1,1]: x_{hq} \in \bar{e}_j} \{u_h(x_{hq}) + hf(x)|q|\} - \delta.$$

for  $\delta > 0$ . Given  $\epsilon < \delta$ , let  $y \in \partial\Gamma$  and  $\gamma_{x,y}^h = \{\gamma_m^h\}_{m=0}^M \in B_{x,y}^h$  be  $\epsilon$ -optimal for  $x$ . By the inequality

$$g(y) + \mathcal{F}_h(\gamma_{x,y}^h) - \epsilon \leq u_h(x) \leq u_h(x_{hq}) + hf(x)|q| - \delta$$

it is clear that if  $y = x_{hq}$  for some  $q \in [-1, 1]$  we get a contradiction. Define  $\bar{\gamma}^h = \gamma_{x,y}^h \setminus \gamma^h$  where  $\gamma^h = \{\gamma_i^h\}_{i=0}^1$  with  $\gamma_0^h = x$ ,  $\gamma_1^h = x_{hq}$ . Since  $\bar{\gamma}^h := \gamma_{x,y}^h \setminus \gamma^h \in B_{x_{hq},y}^h$  we have

$$g(y) + \mathcal{F}_h(\bar{\gamma}^h) = g(y) + \mathcal{F}_h(\gamma_{x,y}^h) - \mathcal{F}_h(\gamma^h) \leq u_h(x_{hq}) + \epsilon - \delta$$

a contradiction to the definition of  $u_h$  and therefore (4.11). The equation (4.12) can be proved in a similar way.

We finally show that the function  $u_h$  is Lipschitz continuous in  $\Gamma$ , uniformly in  $h$ . Consider first the case of two points in the same arc, i.e.  $x_1, x_2 \in \bar{e}_j$  for some  $j \in J$ . Given  $\epsilon > 0$ , denote by  $\gamma^h = \{\gamma_m^h\} \in B_{x_1,x_2}^h$  by

$$\gamma_m^h = \begin{cases} x_1, & m = 0; \\ z_m, & m = 1, \dots, M-1; \\ x_2, & m = M. \end{cases} \quad (4.17)$$

where  $|\pi_j^{-1}(\gamma_m) - \pi_j^{-1}(\gamma_{m+1})| \leq h$  for  $m = 0, \dots, M$ . Let  $y \in \partial\Gamma$  and  $\gamma_1^h \in B_{x_1,y}^h$  be  $\epsilon$ -optimal for  $x_1$ . Then  $\gamma_1^h \cup \gamma^h \in B_{x_2,y}^h$  and

$$\begin{aligned} u_h(x_2) &\leq g(y) + \mathcal{F}_h(\gamma_1^h \cup \gamma^h) \leq g(y) + \mathcal{F}_h(\gamma_1^h) + \mathcal{F}_h(\gamma^h) \\ &\leq u_h(x_1) + C \sum_{m=0}^M h |\pi_j(t_{m+1}) - \pi_j(t_m)| + \epsilon \leq u_h(x_1) + Cd(x_1, x_2) + 2\epsilon \end{aligned}$$

Exchanging the role of  $x_1$  and  $x_2$  we get

$$|u_h(x_1) - u_h(x_2)| \leq Cd(x_1, x_2) \quad (4.18)$$

If  $x_1, x_2 \in \Gamma$ , let  $\gamma$  be such that  $\int_0^T |\dot{\gamma}(s)| ds \leq d(x_1, x_2) + \epsilon$  and  $\{e_{j_m}\}_{m=1}^M \subset J$  such that  $\gamma([0, T]) \subset \cup_{m=1}^M e_{j_m}$ . For each one of the couples  $(x_1, v_{j_1}), (v_{j_m}, v_{j_{m+1}})$  for  $m = 1, \dots, M$  and  $(v_{j_M}, x_2)$  define a trajectory  $\gamma_m^h$  as in (4.17). Then define  $\gamma^h \in B_{x_1, x_2}^h$  by

$$\gamma^h = \begin{cases} x_1, & k = 0; \\ \gamma_k^h & k = \sum_{i=1}^m M_{i-1}, \dots, \sum_{i=1}^m M_{i-1} + M_m - 1; \\ x_2, & m = \bar{M}. \end{cases}$$

where  $\bar{M} = \sum_{i=0}^{M+1} M_i$ . For  $t_k = \pi_{j_m}^{-1}(\gamma_k^h)$ ,  $k = \sum_{i=1}^m M_{i-1}, \dots, \sum_{i=1}^m M_{i-1} + M_m - 1$ , then we have  $t_{k+1} - t_k = hq_k$  with  $|q_k| \leq 1$ . Let  $y \in \partial\Gamma$  and  $\gamma_1^h \in B_{x_1, y}^h$  be  $\epsilon$ -optimal for  $x_1$ . Then  $\gamma_1^h \cup \gamma^h \in B_{x_2, y}^h$  and

$$\begin{aligned} u_h(x_2) &\leq g(y) + \mathcal{F}_h(\gamma_1^h \cup \gamma^h) \leq g(y) + \mathcal{F}_h(\gamma_1^h) + \mathcal{F}_h(\gamma^h) \leq u_h(x_1) + \sum_{k=0}^{\bar{M}} h|q_k|f(\gamma_k^h) + \epsilon \\ &\leq u_h(x_1) + Cd(x_1, x_2) + 2\epsilon. \end{aligned}$$

Exchanging the role of  $x_1$  and  $x_2$  we get (4.18) □

**Remark 4.5.** By Remark 4.4 and the continuity of  $f$ , assumption (4.7) implies

$$g(x) \leq \inf\{\mathcal{F}_h(\gamma) + g(y) : \gamma \in B_{x, y}^h, y \in \partial\Gamma\} + Ch \quad \text{for any } x, y \in \partial\Gamma.$$

Moreover, if  $g \equiv 0$  on  $\partial\Gamma$ , the condition (4.14) is satisfied since  $\mathcal{F}_h(\gamma^h) \geq 0$  for any  $\gamma^h$ .

**Theorem 4.2.** Assume (4.14) for any  $h > 0$  and (4.7). Then for  $h \rightarrow 0$ , the solution  $u_h$  of (4.10) converges uniformly to the unique solution  $u$  of (4.3)-(4.5).

*Proof.* we first observe that (4.3) can be written in equivalent form as

$$\sup_{q \in [-1, 1]} \{-q\partial u(x) - f(x)|q|\} = 0$$

By (4.15),  $u_h$  converges, up to a subsequence, to a Lipschitz continuous function  $u$ . We show that  $u$  is a solution of (4.3) at  $x \in \Gamma$ . We will consider the case  $x = v_i \in I_T$ , as otherwise the argument is standard (see f.e. [3, Th.VI.1.1]).

To show that  $u$  is a *subsolution*, choose any  $j, k \in \text{Inc}_i$ ,  $j \neq k$ , along with an  $(j, k)$ -test function  $\varphi$  of  $u$  at  $x$ . Observe that it is not restrictive to consider  $x$  to be a strict maximum point for  $u - \varphi$ , since we otherwise consider the auxiliary function  $\varphi_\delta(y) := \varphi(y) + \delta d(x, y)^2$  for  $\delta > 0$  with  $\partial_m(d(x, \cdot)^2)(\pi_m^{-1}(x)) = 0$  for  $m = j$  and  $m = k$ . Then there exists  $r > 0$  such that  $u - \varphi$  attains a strict local maximum w.r.t.  $\bar{B}_r(x)$  at  $x$ , where  $B_r(x) := \{y \in \Gamma : d(x, y) < r\}$ . Moreover  $x$  is

a strict maximum point for  $u - \varphi$  also in  $\bar{B} := \bar{B}_r(x) \cap (\bar{e}_j \cup \bar{e}_k)$ . Now choose a sequence  $\omega_h \rightarrow 0$  for  $h \rightarrow 0$  with

$$\sup_{\Gamma} |u(x) - u_h(x)| \leq \omega_h \quad (4.19)$$

and let  $y_h$  be a maximum point for  $u_h - \varphi$  in  $\bar{B}$ . Up to a subsequence,  $y_h \rightarrow z \in \bar{B}$ . Moreover,

$$u(x) - \varphi(x) - \omega_h \leq u_h(x) - \varphi(x) \leq u_h(y_h) - \varphi(y_h) \leq u(y_h) - \varphi(y_h) + \omega_h.$$

For  $h \rightarrow 0$ , we get  $u(x) - \varphi(x) \leq u(z) - \varphi(z)$ . As  $x$  is a strict maximum point, we conclude  $x = z$ . Invoking

$$u_h(x) + \varphi(y_h) - \varphi(x) - \omega_h \leq u_h(y_h) \leq u(y_h) + \omega_h$$

we altogether get

$$\lim_{h \rightarrow 0} y_h = x, \quad \lim_{h \rightarrow 0} u_h(y_h) = u(x) \quad (4.20)$$

We distinguish two cases:

*Case 1:  $y_h \neq x$ .* Then  $y_h \in e_m$  with either  $m = j$  or  $m = k$ . Since  $u_h - \varphi$  attains a maximum at  $y_h$ , then for  $y_h = \pi_m(t_h)$  and  $y_{hq} = \pi_m(t_h - hq) \in \bar{e}_m$

$$u_h(y_h) - \varphi(y_h) \geq u_h(\pi_m^{-1}(y_{hq})) - \varphi(\pi_m^{-1}(y_{hq}))$$

and therefore

$$\sup_{q \in [-1,1]: y_{hq} \in \bar{e}_m} \left\{ -\frac{\varphi(\pi_m^{-1}(y_{hq})) - \varphi(\pi_m^{-1}(y_h))}{h} - h f^m(y_h) |q| \right\} \leq 0 \quad (4.21)$$

The set  $\{q \in \mathbb{R} : \pi_m(t - hq) \in \bar{e}_m\}$  contains for  $h$  small enough either  $[-1, 0]$  if  $a_{i,m} = 1$  or  $[0, 1]$  if  $a_{i,m} = -1$ . Passing to the limit for  $h \rightarrow 0$  in (4.21), since  $f^m(x)|q| = f^m(x) - |q|$  we get

$$\sup_{q \in [-1,1]} \{q \partial_m \varphi(x) - f(x) |q|\} \leq 0.$$

*Case 2:  $y_h = x$ .* Since  $u_h - \varphi$  attains a maximum at  $x$ , then for  $x = \pi_j(t_h)$  and  $y_{hq} = \pi_j(t_h - hq) \in \bar{e}_j$

$$u_h(y_h) - \varphi(y_h) \geq u(y_{hq}) - \varphi(y_{hq})$$

and therefore

$$\sup_{q \in [-1,1]: y_{hq} \in \bar{e}_j} \left\{ -\frac{\varphi_h^j(y_{hq}) - \varphi_h^j(y_h)}{h} - h f^j(y_h) |q| \right\} \leq 0$$

The set  $\{q \in \mathbb{R} : \pi_j(t - hq) \in \bar{e}_j\}$  contains for  $h$  small enough either  $[-1, 0]$  if  $a_{i,j} = 1$  or  $[0, 1]$  if  $a_{i,j} = -1$  and passing to the limit for  $h \rightarrow 0$  we conclude as in the previous case that

$$\sup_{q \in [-1,1]} \{q \partial_j \varphi(x) - f(x) |q|\} \leq 0.$$

To show that  $u$  is a *supersolution*, we assume by contradiction that there exists  $j \in Inc_i$  such that for any  $k \in Inc_i$ ,  $k \neq j$ , there exists a  $(j, k)$ -test function  $\varphi_k$  of  $u$  at  $x$  for which

$$\sup_{q \in [-1,1]} \{q \partial_j \varphi_k(x) - f(x) |q|\} < 0. \quad (4.22)$$

there exists  $r > 0$  such that  $u - \varphi_k$  attains a strict minimum in  $\bar{B}_r(x)$  at  $x$ . Observe that  $x$  is a strict minimum point of  $u - \varphi_k$  also in  $\bar{B}_k := \bar{B}_r(x) \cap (\bar{e}_j \cup \bar{e}_k)$ . Since for any  $h$ , there exists  $k_h$  such that

$$u_h^j(v_i) = \inf_{q \in [-1,1]: \pi_{k_h}(t-hq) \in \bar{e}_{k_h}} \{u_h^{k_h}(\pi_{k_h}(t-hq)) + hf^{k_h}(v_i)|q|\}$$

we may assume, up to a subsequence, that there exists  $k \in Inc_i$  such that  $k_h = k$  for any  $h > 0$ . Let  $y_h$  be a minimum point of  $u_h - \varphi_k$  in  $\bar{B}_k$  and let  $\omega_h$  be as in (4.19). As in the subsolution case, we prove that (4.20) holds. If  $y_h \neq x$ , we have for  $y_h = \pi_m(t_h)$  and  $t_h - hq \in \bar{e}_m$

$$u_h(y_h) - \varphi(y_h) \leq u(\pi_m(t_h - hq)) - \varphi(\pi_m(t_h - hq))$$

and therefore

$$\sup_{q \in [-1,1]: \pi_m(t-hq) \in \bar{e}_m} \left\{ -\frac{\varphi_h^m(\pi_m(t_h - hq)) - \varphi_h^m(y_h)}{h} - hf^m(y_h)|q| \right\} \geq 0$$

for either  $m = j$  or  $m = k$ . If  $y_h = x$ , we get

$$\sup_{q \in [-1,1]: \pi_j(t-hq) \in \bar{e}_j} \left\{ -\frac{\varphi_h^j(\pi_j(t_h - hq)) - \varphi_h^j(y_h)}{h} - hf^j(x)|q| \right\} \geq 0$$

Arguing as in the subsolution case we get for  $h \rightarrow 0$

$$\sup_{q \in [-1,1]} \{q \partial_j \varphi(x) - f(x)|q|\} \geq 0.$$

which is a contradiction to (4.22).

We conclude the proof by observing that the uniqueness of the solution to (4.3) implies that any convergent subsequence  $u_h$  must converge to the unique solution  $u$  of (4.3)-(4.5) and therefore the uniform convergence of all the sequence  $u_h$  to  $u$ .  $\square$

### 4.3.2 Fully discretization in space

In this section we introduce a FEM like discretization of (4.10) yielding a fully discrete scheme. For any  $j \in J$ , given  $\Delta x^j > 0$  we consider a finite partition

$$P^j = \{t_1^j = 0 < \dots < t_m^j < \dots < t_{M_j}^j = l_j\}$$

of the interval  $[0, l_j]$  such that  $|P^j| = \max_{1, \dots, M_j} (t_m^j - t_{m-1}^j) \leq \Delta x^j$ . We set

$$\Delta x = \max_{j \in J} \Delta x^j, \quad M = \sum_{j \in J} M_j \quad (4.23)$$

The partition  $P^j$  induces a partition of the arc  $\bar{e}_j$  given by the points

$$x_m^j = \pi_j(t_m^j), \quad m = 1, \dots, M_j.$$

and we set  $X_{\Delta x} = \cup_{j \in J} \cup_{m=1}^{M_j} x_m^j$ .

In each interval  $[0, l_j]$  we consider a family of basis functions  $\{\beta_m^j\}_{m=0}^{M_j}$  for the space of continuous, piecewise linear functions in the intervals of the partition  $P^j$ . Hence  $\beta_m^j$  are piecewise linear functions satisfying  $\beta_m^j(t_k) = \delta_{mk}$  for  $m, k \in \{1, \dots, M_j\}$   $0 \leq \beta_m^j(t) \leq 1$ ,  $\sum_{m=1}^{M_j} \beta_m^j(t) = 1$  and for any  $t \in [0, l_j]$  at most 2  $\beta_m^j$ 's are non-zero. We define  $\bar{\beta}_j : \bar{e}_j \rightarrow \mathbb{R}$  by

$$\bar{\beta}_m^j(x) = \beta_m^j(\pi_j^{-1}(x)).$$

Given  $W \in \mathbb{R}^M$  we denote by  $I_{\Delta x}[W]$  the interpolation operator defined on the arc  $\bar{e}_j$  by

$$I_{\Delta x}^j[W](x) = \sum_{m=1}^{M_j} \bar{\beta}_m^j(x) W_m^j = \sum_{m=1}^{M_j} \beta_m^j(\pi_j^{-1}(x)) W_m^j \quad x \in \bar{e}_j.$$

We consider the approximation scheme

$$U = \mathcal{S}(\Delta x, h, U) \quad (4.24)$$

where the scheme  $\mathcal{S} = \{\mathcal{S}(\Delta x, h, W)\}_{j \in J}$  is given by

$$\mathcal{S}_m^j(\Delta x, h, W) = \inf_{q \in [-1, 1]: x_m^j(q) \in \bar{e}_j} \{I^j[W](x_m^j(q)) + hf(x_m^j)|q|\} \quad \text{if } x_m^j \in e_j \quad (4.25)$$

$$\mathcal{S}_m^j(\Delta x, h, W) = \inf_{\substack{q \in [-1, 1]: x_m^k(q) \in \bar{e}_k \\ k \in Inc_i}} \{I^k[W](x_m^k(q)) + hf(x_m^k)|q|\} \quad \text{if } x_m^j = v_i \in I_T \quad (4.26)$$

$$\mathcal{S}_m^j(\Delta x, h, W) = g(v_i) \quad \text{if } x_m^j = v_i, i \in I_B \quad (4.27)$$

for  $x_m^j(q) = \pi^j(t_m^j - hq)$ .

**Proposition 4.2.** *For any  $\Delta x > 0$  with  $\Delta x \leq h/2$ , there exists a unique solution  $U \in \mathbb{R}^M$  to (4.25)–(4.27). Moreover, defined  $u_{h\Delta x}(x) = I_{\Delta x}[U]$ , if  $\Delta x = o(h)$  for  $h \rightarrow 0$ , then  $u_{h\Delta x}$  converges to the unique solution  $u$  of (4.3)–(4.5) uniformly in  $\Gamma$ .*

*Proof.* We show the boundedness of a solution to (4.24) by induction. For this purpose we number the nodes  $x_i$  such that  $d(x_{i+1}, \partial\Gamma) \geq d(x_i, \partial\Gamma)$  for all  $i = 1, \dots, M$ , and claim that

$$|U_i| \leq \sup_{x \in \partial\Gamma} |g(x)| + h(L_g + M_f) + 2M_f d(x_i, \partial\Gamma).$$

For each  $x_i$  with  $d(x_i, \partial\Gamma) \leq h$  this estimate is immediate. Now assume the assertion is true for all  $x_i$  with  $i = 1, \dots, l-1$ . For  $x_l \in \bar{e}_j$  by (4.24) we obtain the inequality

$$U_l \leq hf(x_l)|q| + I^j[U](x_l^j(q)) \leq hM_f + I^j[U](x_l^j(q))$$

for any  $q \in \mathbb{R}^n$  with  $|q| \leq 1$  and  $x_l^j(q) \in \bar{e}_j$ . Choosing  $q$  such that  $d(x_l^j(q), \partial\Gamma) = d(x_l, \partial\Gamma) - h$  and using  $\Delta x \leq h/2$  we obtain that the value  $I^j[U](x_l^j(q))$  only depends on nodes  $x_{i_k}$  with

$d(x_{i_k}, \partial\Gamma) \leq d(x_l, \partial\Gamma) - h/2$ , thus  $i_k < l$ . Picking that node  $x_{i_k}$  such that  $U_{i_k}$  becomes maximal, and using the induction assumption we can conclude

$$U_l \leq M_f h + U_{i_k} \leq M_f h + \sup_{x \in \partial\Gamma} |g(x)| + h(L_g + M_f) + 2M_f(d(x_l, \partial\Gamma) - h/2)$$

i.e. the assertion.

To show existence of a unique solution  $U$  we apply the transformation

$$\tilde{U} = 1 - e^{-U}$$

to (4.24). Hence  $\tilde{U}$  is a solution to

$$\tilde{U} = \tilde{\mathcal{S}}(\Delta x, h, U) \tag{4.28}$$

where

$$\begin{aligned} \tilde{\mathcal{S}}_m^j(\Delta x, h, \tilde{W}) &= \inf_{q \in [-1, 1]: x_m^j(q) \in \bar{e}_j} \{e^{-hf(x_m^j)} I^j[\tilde{W}](x_m^j(q)) + 1 - hf(x_m^j)|q|\} && \text{if } x_m^j \in e_j \\ \tilde{\mathcal{S}}_m^j(\Delta x, h, \tilde{W}) &= \inf_{\substack{q \in [-1, 1]: x_m^k(q) \in \bar{e}_k \\ k \in \text{Inc}_i}} \{e^{-hf(x_m^k)} I^k[\tilde{W}](x_m^k(q)) + 1 - hf(x_m^k)|q|\} && \text{if } x_m^j = v_i \in I_T \\ \tilde{\mathcal{S}}_m^j(\Delta x, h, \tilde{W}) &= 1 - e^{-g(v_i)} && \text{if } x_m^j = v_i, i \in I_B \end{aligned}$$

As in the proof of Proposition 4.14 we show that  $\tilde{\mathcal{S}}$  is a contraction in  $\mathbb{R}^M$  and we conclude that there exists a unique bounded solution to (4.28) and therefore to (4.24).

To show the convergence of  $u_{h\Delta x}$  to  $u$ , we set  $\tilde{u}_h = 1 - e^{-u_h}$ ,  $\tilde{u}_{h\Delta x} = 1 - e^{-u_{h\Delta x}}$  and we estimate for  $x \in \bar{e}_j$

$$|\tilde{u}_h(x) - \tilde{u}_{h\Delta x}(x)| \leq |\tilde{u}_h(x) - I^j[\tilde{U}^h](x)| + |I^j[\tilde{U}^h](x) - I^j[\tilde{U}](x)| \tag{4.29}$$

where  $\tilde{U}^h, \tilde{U}$  are the vectors of the values of  $\tilde{u}_h, \tilde{u}_{h\Delta x}$  at the nodes of the grid. By the Lipschitz continuity and boundedness of  $u_h$  we get

$$|\tilde{u}_h(x) - I^j[\tilde{U}^h](x)| \leq C\Delta x \tag{4.30}$$

with  $C$  independent of  $h$ . Moreover, by (4.16) and (4.28) we get for  $x_k = \pi_j^{-1}(t_k) \in e_j$ ,  $x_{hq} := \pi_j(t_k - hq)$  and since  $x_k^j(q) = x_{hq}$

$$|\tilde{U}_k^h - \tilde{U}_k| \leq e^{-hf(x_k)} |\tilde{u}_h(x_{hq}) - I^j[\tilde{U}](x_k^j(q))| \leq e^{-h\eta} \|\tilde{u}_h - \tilde{u}_{h\Delta x}\|_\infty \tag{4.31}$$

where  $\eta$  as in (4.4). Substituting (4.30) and (4.31) in (4.29) we get

$$\|\tilde{u}_h - \tilde{u}_{h\Delta x}\|_\infty \leq \frac{C}{1 - e^{-\eta h}} \Delta x$$

and therefore, taking into account Theorem 4.2, we have that if  $\Delta x = o(h)$  for  $h \rightarrow 0$ , then  $u_{h\Delta x}$  converges to  $u$  uniformly on  $\Gamma$ .  $\square$



## 4.4 Implementation of the scheme and numerical tests

In this section we discuss the numerical implementation of the scheme described in the previous section and we present some numerical examples. We remark again that the most interesting feature of our approach is that it is intrinsically one-dimensional, even if the graph is embedded in  $\mathbb{R}^N$ . For this reason it does not present the typical curse of dimensionality issue which is usually encountered in solving Hamilton-Jacobi equations on  $\mathbb{R}^N$ .

The numerical implementation of semiLagrangian schemes has been extensively discussed in previous works (see for example the Appendix B in [3]), hence the only regard is due to vertices, where the information could come from different arcs. We briefly describe the logical structure of the algorithm we use to compute the solution.

Let  $A$  be the  $m \times m$  incidence matrix defined in (4.1). We also define a matrix  $BC$  which contains the information on boundary vertices, in particular:  $BC(\cdot, 1)$  represents a boundary vertex and  $BC(\cdot, 2) =$  the value of the Dirichlet datum at that vertex. The number of the edges is at most  $n = \frac{(m-1)m}{2}$  and, after having ordered the edges, we define the *auxiliary edges matrix*  $B \in M^{3,n}$  where the  $i$ -row contains the following information:

- $B(i, 1) = \# \text{knot where the } i\text{-arc starts,}$
- $B(i, 2) = \# \text{knot where the } i\text{-arc ends,}$
- $B(i, 3) = \text{length of the discretized } i\text{-arc,}$

We choose the same discretization step  $\Delta x \equiv \Delta x_i$  for every edge, so that the approximated length of the edge  $i$  is  $L_i = \text{trunc}(\frac{B(i,3)}{\Delta x}) \in \mathbb{N}^+$  and we consider a finite partition

$$P^i = \{t_0^i = 0, t_1^i = \Delta x, t_2^i = 2\Delta x, \dots, t_{M_i-1}^i = (M_i - 1)\Delta x, t_{M_i}^i = B(i, 3)\}. \quad (4.32)$$

The matrix  $C$ , contains the grid points of the graph, i.e. for the edge  $i$

$$C(i, j) = \pi_i(t_j^i) \quad j = 0, \dots, M_i \quad (4.33)$$

Finally, we denote by  $U(i, j)$  the the approximated solution at the point  $C(i, j)$  point. We solve the problem using the following iteration

### HJ-networks algorithm.

---

1. Initialize

$$U = U_0 ;$$

$$\text{it}=0;$$

2. Until convergence, Do

3. for  $i=0$  to  $n$
4.     If  $B(i, 1)$  appears in  $BC(\cdot, 1)$  to  $s$
5.         then  $U(i, 0) = BC(s, 2)$ ;
6.     else
7.          $U(i, 0) = \min \left\{ \min_{\{k|A(B(i,1),k)=1\}} \left\{ I[U](C(k, \frac{h}{\Delta x})) \right\}, \right.$   
 $\left. \min_{\{k|A(B(i,1)=-1\}} \left\{ I[U](C(k, B(k, 3) - \frac{h}{\Delta x})) \right\} \right\} + hf(C(i, j))$
8.     for  $j = 0$  to  $B(i, 3) - 1$
9.          $U(i, j) = \min_{a \in [-1, 1]} \left\{ I[U](C(i, j + \frac{ah}{\Delta x})) \right\} + hf(C(i, j))$
10.     If  $B(i, 2)$  appears in  $BC(\cdot, 1)$  to  $s$
11.         then  $U(i, B(i, 3)) = BC(s, 2)$ ;
12.     else
13.          $U(i, B(i, 3)) = \min \left\{ \min_{\{k|A(B(i,2)=1\}} \left\{ I[U](C(k, \frac{h}{\Delta x})) \right\}, \right.$   
 $\left. \min_{\{k|A(B(i,2)=-1\}} \left\{ I[U](C(k, B(k, 3) - \frac{h}{\Delta x})) \right\} \right\} + hf(C(i, j))$
14. re-initialize vertex on  $U$
15. EndDo

---

The interpolation  $I[U](C(i, x))$  is the usual linear interpolation, i.e.

$$\begin{aligned}
 I[C](x) &= C(i, \text{trunc}(x)) + (x - \text{trunc}(x))C(i, \text{trunc}(x) + 1) - C(i, \text{trunc}(x)) \\
 I[U](C(i, x)) &= U(i, \text{trunc}(x)) + (I[C](x) - C(i, \text{trunc}(x))) \frac{U(i, \text{trunc}(x) + 1) - U(i, \text{trunc}(x))}{C(i, \text{trunc}(x) + 1) - C(i, \text{trunc}(x))}
 \end{aligned} \tag{4.34}$$

**Remark 4.6.** *The order given to the edges, which is necessary for define the previous iteration, brings some additional problems that we have to consider:*

- *At the end of each iteration of the method, the values of the solution at a same vertex, which is contained in different arcs, could be different. Hence we make a re-initialization, choosing for every vertex the minimum of the previous values.*
- *It is also important that the initial guess  $U_0$  of the solution we use to initialize the algorithm is greater than the solution. In fact, if this condition is not satisfied, for particular choices of the discretization step the algorithm could generate a fake minimum of the solution.*

In the first test we consider a five knots graph with two straight arcs and two sinusoidal ones (see figure 4.2). The only boundary knot is the one placed at the origin and the value of the

solution at this knot is fixed to zero. The cost function is constant, i.e.  $f(x) \equiv 1$  on  $\Gamma$ . In this case the correct solution is

$$\begin{aligned} u(x) &= \text{dist}(x, 0) = \sqrt{x_1^2 + x_2^2} \quad \text{for the straight arcs} \\ u(x) &= \int_0^{|x|} (\sqrt{1 + (2\pi \cos 2\pi t)}) dt \quad \text{for sinusoidal arcs} \end{aligned} \quad (4.35)$$

In table 4.1, we compare the exact solution with the approximate one obtained by the scheme. We observe a numerical convergence to the the correct solution in  $L_2$ -norm and in the uniform one.

In the second test we present a more complicated graph with two boundary vertices and a several connections among the arcs. Also in this case, we consider a constant cost function  $f(x) \equiv 1$  on  $\Gamma$ . In table 4.2 and in figure 4.5 we show our results.

In the last test we consider a five knots graph (figure 4.6), with a running cost which is not constant. For any point on the graph  $x = (x_1, x_2) \in \Gamma$ , we take  $f(x) = 10(x_1 - 1) + \eta$ , hence  $f(x) \geq \eta > 0$  for  $x \in \Gamma$ . In the example, we set  $\eta = 10^{-10}$ . The graph of the approximate solution is shown in figure 4.7.

$\Delta x = h$	$\ \cdot\ _\infty$	$Ord(L_\infty)$	$\ \cdot\ _2$	$Ord(L_2)$
<b>0.2</b>	0.1468		0.1007	
<b>0.1</b>	0.0901	0.7043	0.0639	0.6562
<b>0.05</b>	0.0630	0.5162	0.0491	0.3801
<b>0.025</b>	0.0450	0.4854	0.0402	0.2885
<b>0.0125</b>	0.0321	0.4874	0.029	0.4711

Table 4.1: Test 1.

$\Delta x = h$	$\ \cdot\ _\infty$	$Ord(L_\infty)$	$\ \cdot\ _2$	$Ord(L_2)$
<b>0.2</b>	0.1716		0.0820	
<b>0.1</b>	0.0716	1.2610	0.0297	1.4652
<b>0.05</b>	0.0284	1.3341	0.0127	1.2256
<b>0.025</b>	0.0126	1.1611	0.0072	0.8188

Table 4.2: Test 2.

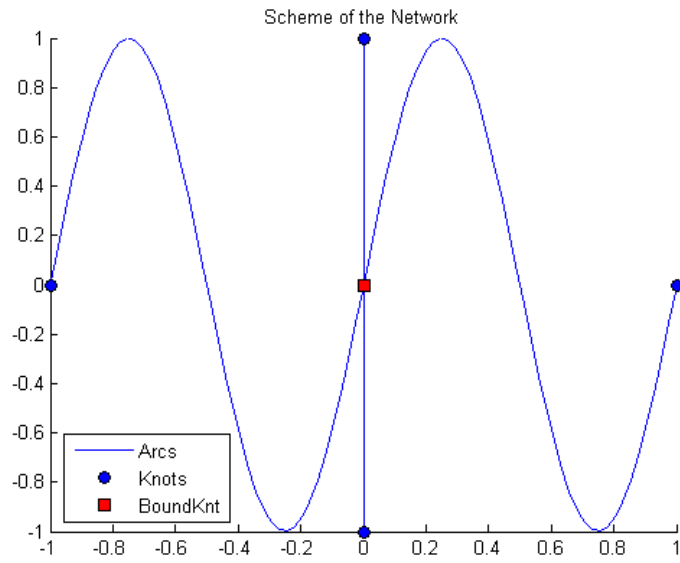
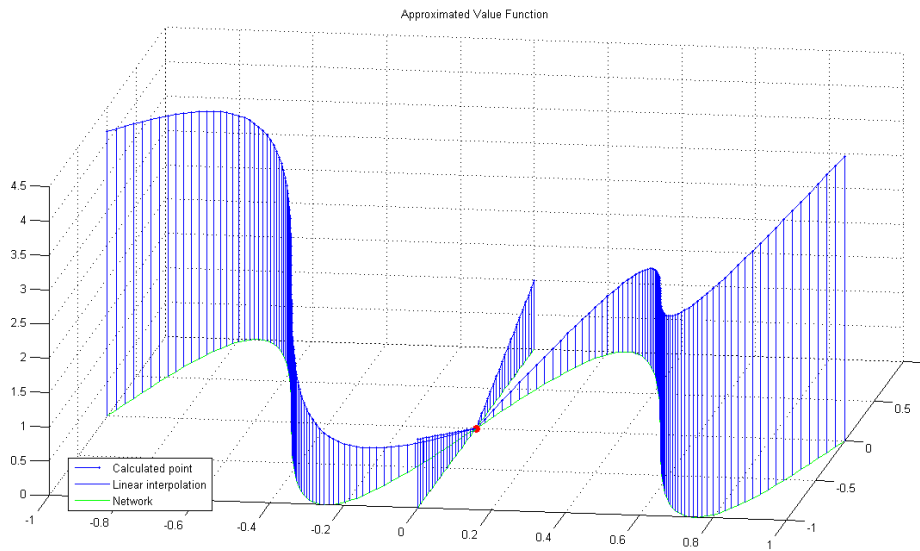

Figure 4.2: Test 1, structure of the graph.

Figure 4.3: Test 1,  $\Delta x = 0.025$ .

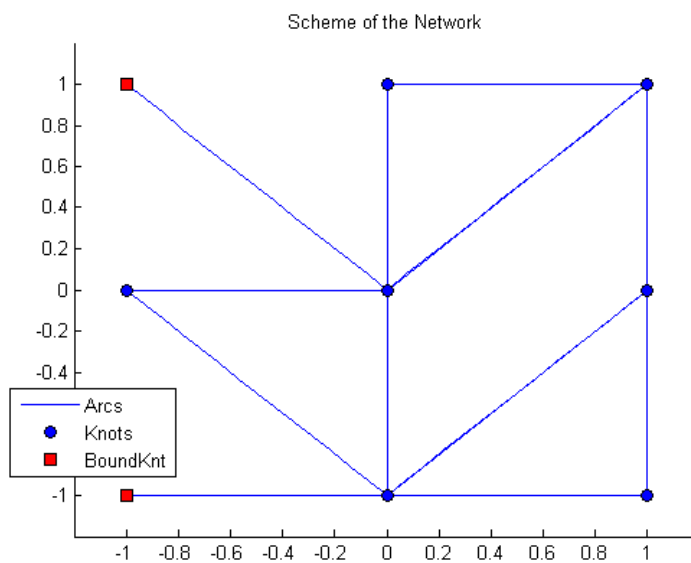

Figure 4.4: Test 2, structure of the graph.

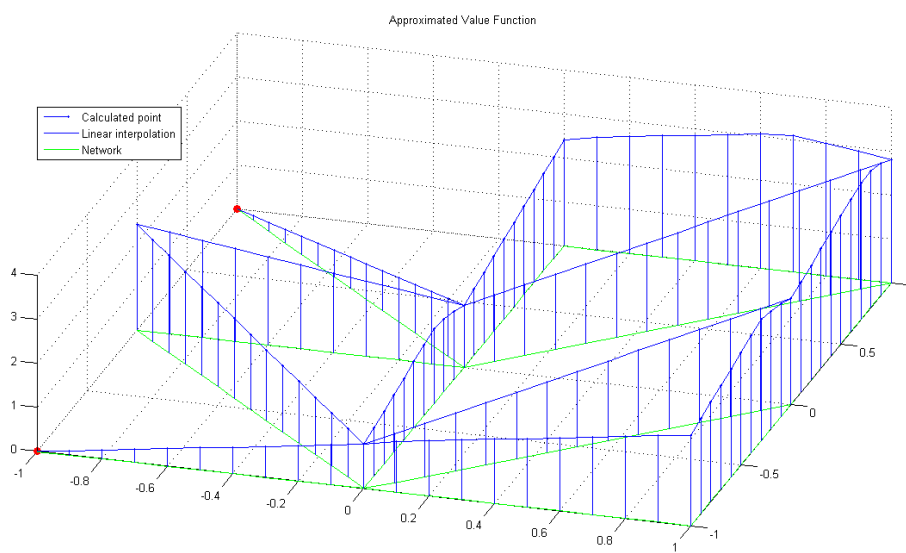

Figure 4.5: Test 2,  $\Delta x = 0.1$ .

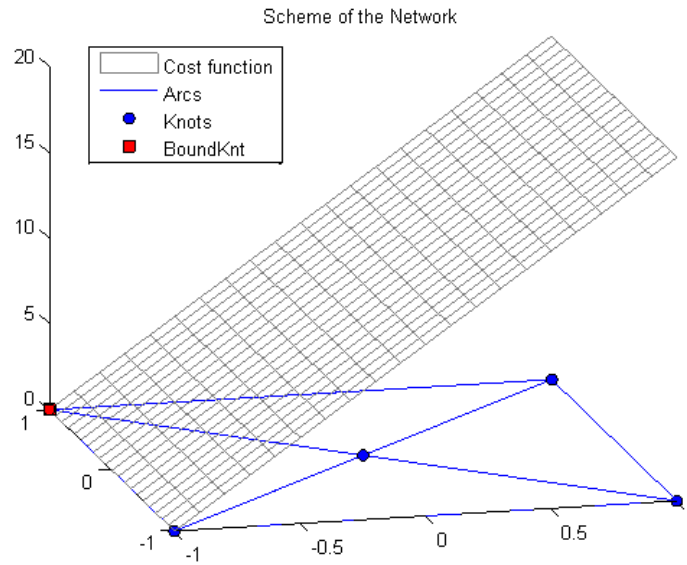
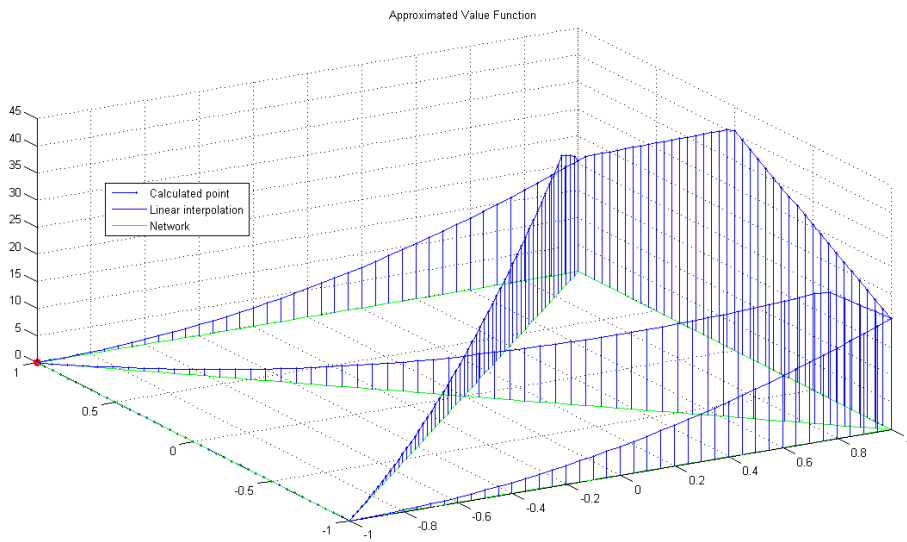

Figure 4.6: Test 3, structure of the graph.

Figure 4.7: Test 3,  $\Delta x = 0.05$ .

## Chapter 5

# Applications

### 5.1 The SFS problem

#### 5.1.1 The model

The Shape-from-Shading problem consists in reconstructing the three-dimensional shape of a scene from the brightness variation (shading) in a greylevel photograph of that scene (see Fig. 5.1). The study of the Shape-from-Shading problem started in the 70s (see [32] and references

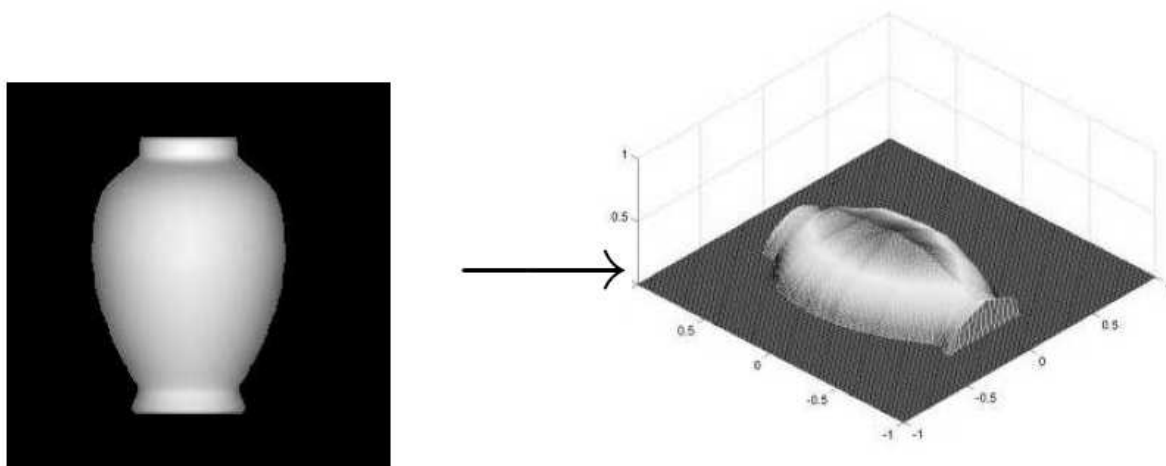

Figure 5.1: Initial image (left) and reconstructed surface (right).

therein) and since then a huge number of papers have appeared on this subject. More recently, the mathematical community was interested in Shape-from-Shading since its formulation is based on a first order partial differential equation of Hamilton-Jacobi type. Unfortunately, the

numerous assumptions usually introduced in order to make the problem manageable highly reduce the relevance of the models.

The most common assumptions are (see [19]):

- H1 - The image reflects the light uniformly and then the albedo (ratio between energy reflected and energy captured) is constant.
- H2 - The material is Lambertian, i.e. the intensity of the reflected light is proportional to the scalar product between the direction of the light and the normal to the surface.
- H3 - The light source is unique and the rays of light which lighten the scene are parallel.
- H4 - Multiple reflections are negligible.
- H5 - The aberrations of the objective are negligible.
- H6 - The distance between the scene and the objective is much larger than that between the objective and the CCD sensor.
- H7 - The perspective deformations are negligible.
- H8 - The scene is completely visible by the camera, i.e. there are not hidden regions.

**Remark 5.1.** *Assumptions H1 and H2 are often false for a common material.*

*Assumption H3 means that we can describe the light direction by a unique and constant vector. Note that this is true only if the light source is very far from the scene (for example, if the scene is illuminated by the sun). Naturally, this assumption does not hold in case of flash illumination.*

*Assumption H7 means that the camera is very far from the scene and it is obviously false in most cases.*

Let us briefly derive the model for Shape-from-Shading under general assumptions. Let  $\Omega$  be a bounded set of  $\mathbb{R}^2$  and let  $u(x, y) : \Omega \rightarrow \mathbb{R}$  be a surface which represents the three-dimensional surface we want to reconstruct. The partial differential equation related to the Shape-from-Shading model can be derived by the “image irradiance equation”

$$R(n(x, y)) = I(x, y) \tag{5.1}$$

where  $I$  is the brightness function measured at all points  $(x, y)$  in the image,  $R$  is the reflectance function giving the value of the light reflection on the surface as a function of its orientation (i.e. of its normal) and  $n(x)$  is the unit normal to the surface at point  $(x, y, u(x, y))$ . If the surface is smooth we have

$$n(x; y) = \frac{(-u_x(x, y), -u_y(x, y), 1)}{\sqrt{1 + |Du(x, y)|^2}}. \tag{5.2}$$

The brightness function  $I$  is the datum in the model since it is measured on each pixel of the image in terms of a gray level, for example from 0=black to 255=white or, after a rescaling,



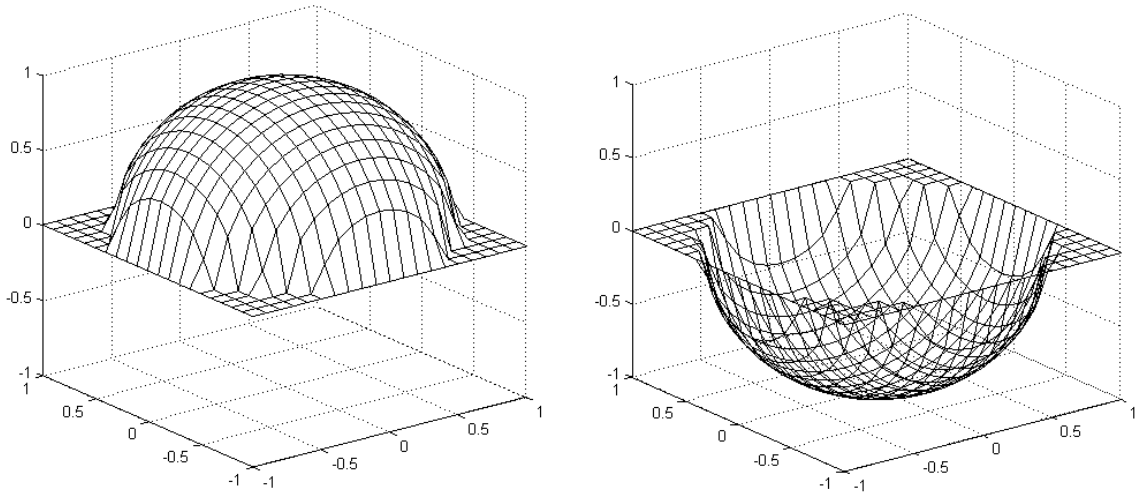

Figure 5.2: Two different surfaces corresponding to the same image  $I$ .

from 0 to 1. To construct a continuous model we will assume hereafter that  $I$  takes real values in the interval  $[0, 1]$ .

Clearly, equation (5.1) can be written in different ways depending on which assumptions H1-H8 hold true.

**Example 3.** *It is important to note that, whatever the final equation is, in order to compute a solution we will have to impose some boundary conditions on  $\partial\Omega$  and/or inside  $\Omega$ . A natural choice is to consider Dirichlet type boundary conditions in order to take into account at least two different possibilities. The first corresponds to the assumption that the surface is standing on a flat background, i.e. we set*

$$u(x, y) = 0 \quad (x, y) \in \partial\Omega \quad (5.3)$$

*The second possibility occurs when the height of the surface on the boundary is known*

$$u(x, y) = g(x, y) \quad (x, y) \in \partial\Omega \quad (5.4)$$

*The above boundary conditions are widely used in the literature although they are often unrealistic since they assume a previous knowledge of the surface. We will come back later on this problem.*

*Under assumptions H1-H8, we have*

$$R(n(x, y)) = \omega \cdot n(x, y) \quad (5.5)$$

*where  $\omega \in \mathbb{R}^3$  is a unit vector which indicates the direction of the light source. Then, equation (5.1) can be written, using (5.2)*

$$I(x) \sqrt{1 + |Du(x, y)|^2} + (\omega_1, \omega_2) \cdot Du(x, y) - \omega_3 = 0, \quad (x, y) \in \Omega \quad (5.6)$$

which is a first order non-linear partial differential equation of the Hamilton-Jacobi type.

If the light source is vertical, i.e.  $\omega = (0, 0, 1)$ , then equation (5.6) simplifies to the eikonal equation.

$$|Du(x, y)| = \left( \sqrt{\frac{1}{I(x, y)^2} - 1} \right), \quad (x, y) \in \Omega. \quad (5.7)$$

Points  $(x, y)$  where  $I$  is maximal (i.e. equal to 1) correspond to the particular situation when  $\omega$  and  $n$  point in the same direction. These points are usually called “singular points” and, if they exist, equation (5.7) is said to be degenerate (see Remark 1.2). The notion of singular points is strictly related to that of concave/convex ambiguity which we briefly recall in the following example.

The SFS problem is one of the most famous examples of ill-posed problem.

Consider for example the two surfaces  $z = +\sqrt{1 - x^2 - y^2}$  and  $z = -\sqrt{1 - x^2 - y^2}$  (see Fig. 5.2). It is easy to see that they have the same brightness function  $I$  and verify the same boundary condition so that they are virtually indistinguishable by the model. As a consequence, even if we compute a viscosity solution of the equation, it is possible that the solution we obtained is different from the surface we expect. Note that this is an intrinsic problem and it can not be completely solved without a modification of the model.

In order to overcome this difficulty, the problem is usually solved by adding some informations such as the height at the singular points (see [42]). More recently, an attempt has been made to eliminate the need for a priori additional information by means of the characterization of the maximal solution (see [16, 17]). A result by Ishii and Ramaswamy [37] guarantees that if  $I$  is continuous and the number of singular points is finite, then a unique maximal solution exists. Following this approach, some algorithms to approximate the unique maximal solutions were proposed (see for example [19] and references therein).

### 5.1.2 Simulations

In order to solve the Shape from Shading problem in the case of vertical light, we will use the numerical method presented in Chapter 2.

As introduced before we are in the case considered, with

$$f(x) = \left( \sqrt{\frac{1}{I(x)^2} - 1} \right) \quad x \in \Omega. \quad (5.8)$$

Let us focus on two important points:

- We note that a digital image is always a discontinuous datum. It is a piecewise constant function with a fixed measure of his domain of regularity (th pixel). So this is the interest of our analysis for discontinuous cases of  $f$ .

- In the case of maximal gray tone ( $I(x) = 1$ ), we are not in the Hypothesis introduced in Chapter 2. In particular we have that  $f = 0$  in some points. We overcome this difficulty, as suggest in [16]. We regularize the problem making a truncation of  $f$ . We solve the problem with the following  $f_\epsilon$

$$f_\epsilon = \begin{cases} f(x) = \left( \sqrt{\frac{1}{I(x)^2} - 1} \right) & \text{if } f > \epsilon \\ \epsilon & \text{if } f \leq \epsilon \end{cases} \quad (5.9)$$

It is possible to show that this regularized problem goes to the maximal subsolution of the problem with  $\epsilon \rightarrow 0^+$ . And that this particular solution is the correct one from the applicative point of view. For more details [16, 19].

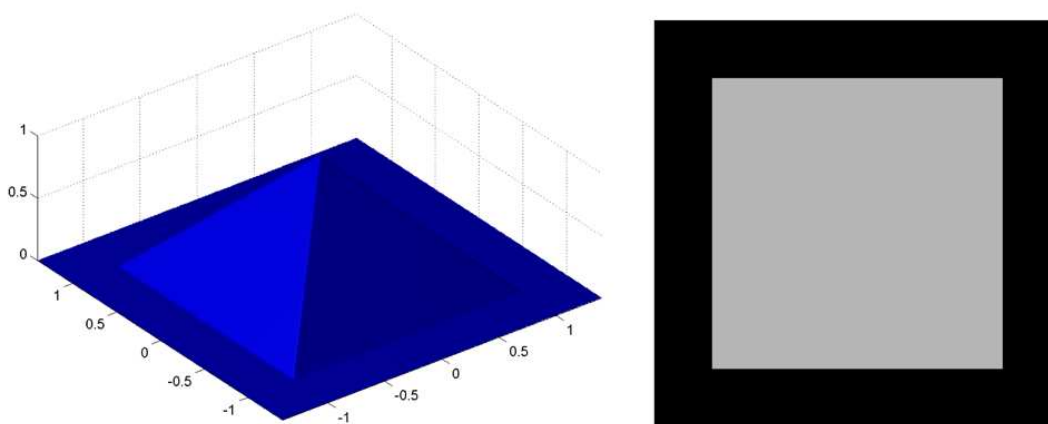

Figure 5.3: Pyramid: original shape and sfs-datum.

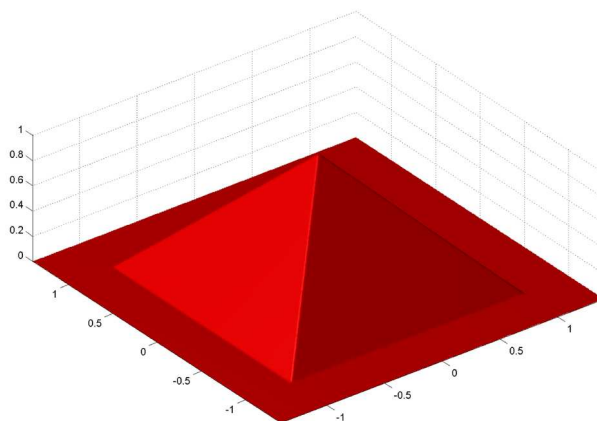

Figure 5.4: Pyramid: reconstructed shape.

We start with a simple example, a pyramid. The datum is synthetic, we mean that we have build a surface and then take a picture of it. After this, we try to reconstruct the original surface. We

take  $\Omega := [-1.2, +1.2]^2$  and the pyramidal surface is the following

$$U = \begin{cases} \min(1 - |x_1|, 1 - |x_2|) & \text{if } \max(|x_1|, |x_2|) < 1 \\ 0 & \text{otherwise} \end{cases} \quad (5.10)$$

the synthetic datum and the original surface is shown in Figure 5.3. We build a numerical approximation, with  $\Delta x = 0.01$ ,  $\Delta t = 0.001$  and  $\epsilon = 10^{-5}$ . We obtain the result shown in Figure 5.4. In this case the result is excellent. We have to say, anyway, that this is a very simple case with no points where the eikonal equation degenerates.

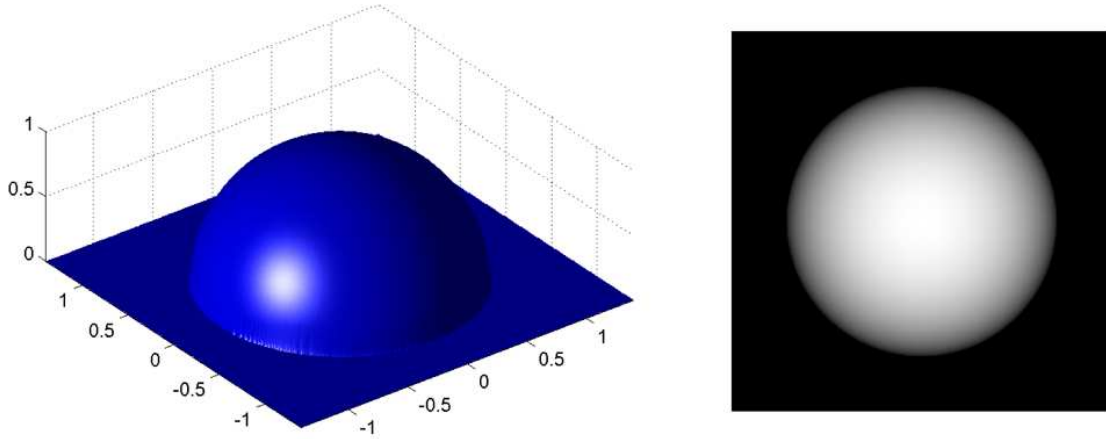

Figure 5.5: Half sphere: original shape and sfs-datum.

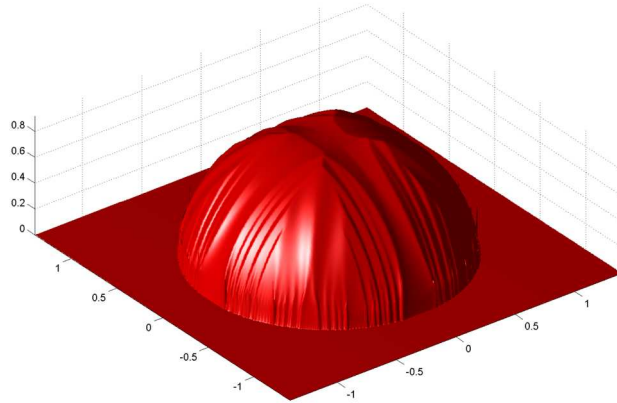

Figure 5.6: Half sphere: reconstructed shape.

The second case which we consider is a bit more complicated. We consider a half sphere, so we find a point where  $f$  runs to zero. Also in this case we make a synthetic image from an original shape and then we try to reconstruct it. We take  $\Omega := [-1.2, +1.2]^2$ , the original shape is

$$U = \begin{cases} \sqrt{1 - x_1^2 - x_2^2} & \text{if } \text{dist}(x_1, x_2) < 1 \\ 0 & \text{otherwise} \end{cases} \quad (5.11)$$

the synthetic datum and the original surface is shown in Figure 5.5. We build a numerical approximation, with  $\Delta x = 0.01$ ,  $\Delta t = 0.001$  and  $\epsilon = 10^{-5}$ . We obtain the result shown in Figure 5.6.

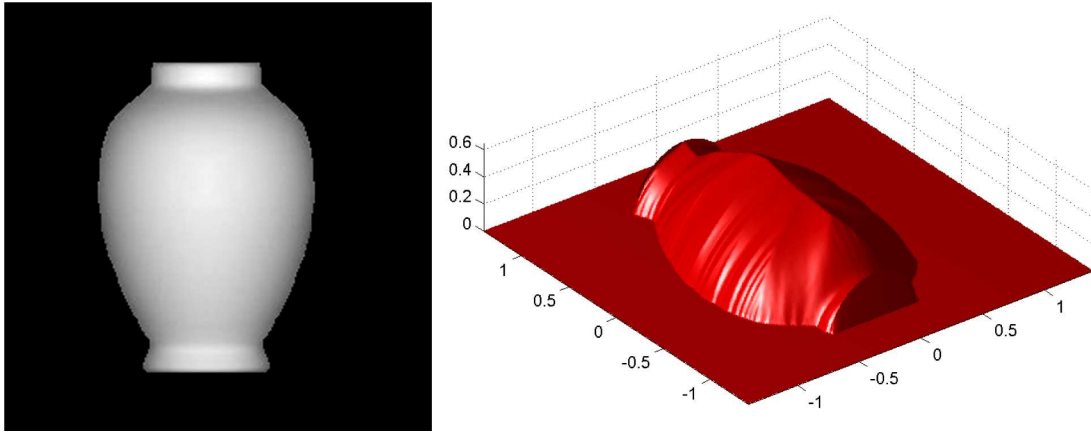

Figure 5.7: Vase: Sfs-datum and reconstructed image.

The last example is relative to a real image of a vase. It is a  $256 \times 256$  image. We have to remark that this case is more difficult than the previous ones. We have several points of maximum value of  $I$  and some noise in the sfs-datum. Furthermore we have the problem of the boundary, where we do not know, a priori, the correct value of  $U$ . We have chosen to impose zero across the lateral *silhouette* of the shape, and a half circle on the superior and inferior silhouette of the vase. This choice is made to preserve the convexity of the shape also in these areas. We take  $\Delta t = 0.0005$  and  $\epsilon = 10^{-6}$ . The result is shown in Figure 5.7.

We consider, now a test with a precise discontinuity on  $I$ , and we will discuss some issue about this case.

We firstly consider a simple problem in 1D. Let the function  $I$  be

$$I = \begin{cases} \sqrt{1-x^2} & \text{if } -1 \leq x < 0.2 \\ \frac{\sqrt{2}}{2} & \text{if } 0.2 \leq x < 1 \\ 0 & \text{otherwise} \end{cases} \quad (5.12)$$

we can see that we have a discontinuity on  $x = 0.2$ ; despite this, as we have shown on Chapter 2, the solution will be continuous. For this reason we can see that changing the boundary condition of the problem, the solution will be the maximal Lipschitz solution that verifies continuously the boundary condition. To see this we have solved this simple monodimensional problem with various Dirichlet conditions, in particular we require  $u(-1) = 0$ , and  $u(1) = \{-1, 0.5, 0, 0.5, 1\}$ . With  $\Delta x = 0.01$  and  $\Delta t = 0.002$ , we obtain the results shown in Figure 5.8.

We can realize, in this way, an intrinsic limit of the model. It can not represent an object with discontinuities. We make another example that is more complicated and more close to a real application.

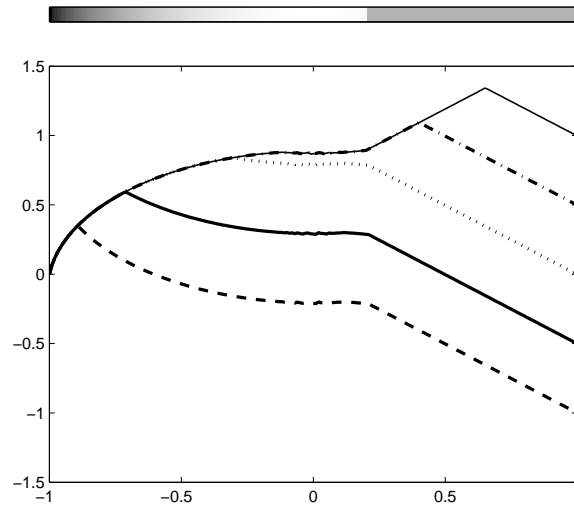

Figure 5.8: Sfs-data and solution with various boundary values.

We consider a simplified sfs-datum for the Basilica of Saint Paul Outside the Walls in Rome, as shown in Figure 5.9. We have not the correct boundary value on the silhouette of the image and on the discontinuities, so we impose simply  $u \equiv 0$  on the boundary. Computing the equation with  $\Delta t = 0.001$  we get the solution described on Figure 5.10. We can see that, although the main features of the shape as the slope of the roofs, the points of maximum are well reconstructed, there are some limits of the model to reconstruct walls (i.e. discontinuities of the solution). We can add some information about this imposing some boundary condition on the discontinuities of the image, obtaining a well-reconstruction of the original shape. This is presented in Figure 5.12.

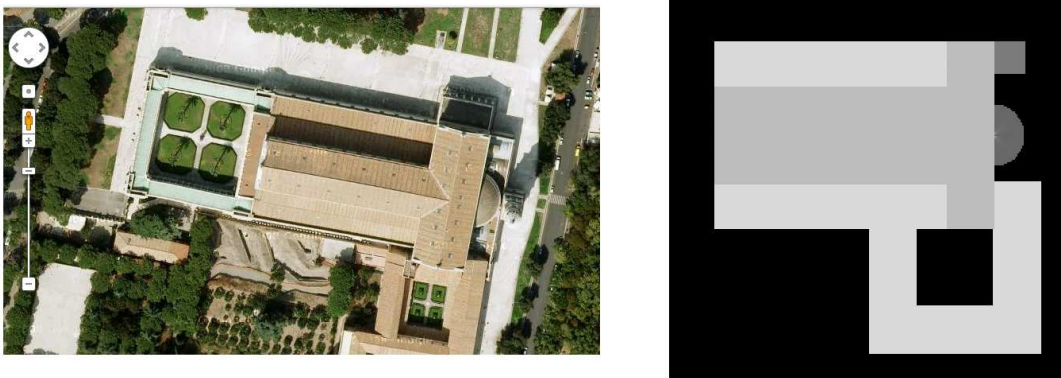

Figure 5.9: Basilica of Saint Paul Outside the Walls: satellite image and simplified sfs-datum.

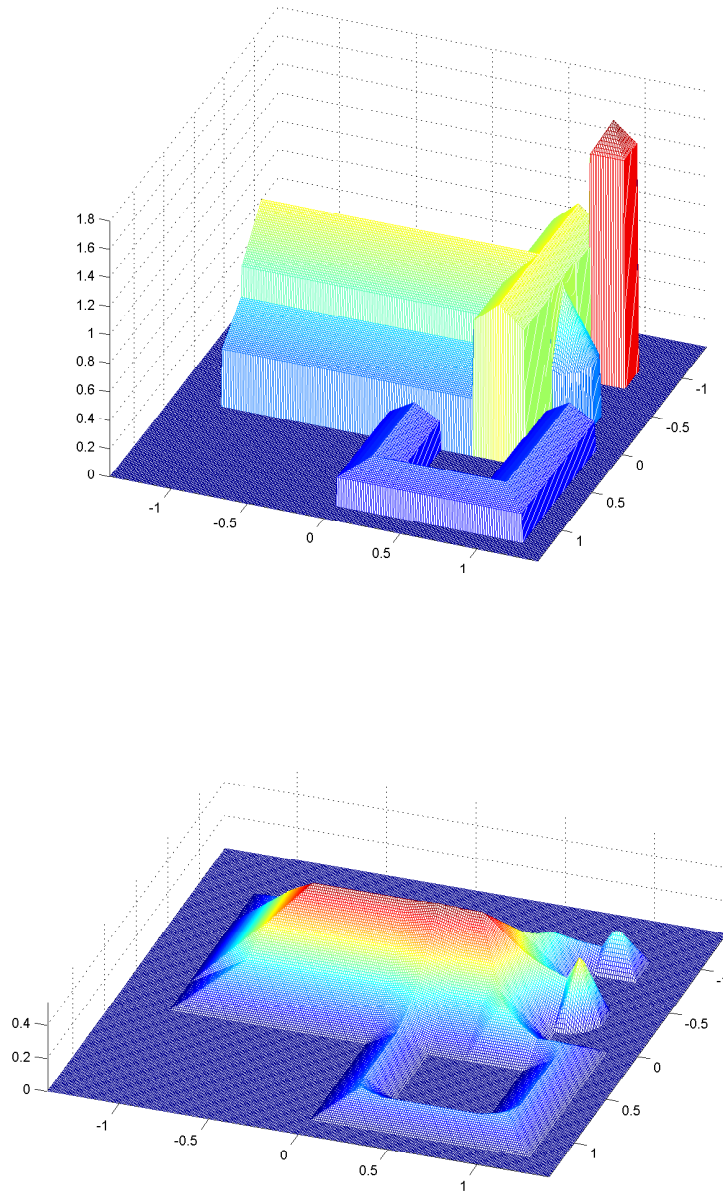

Figure 5.10: Basilica: Original shape and reconstructed without boundary data.



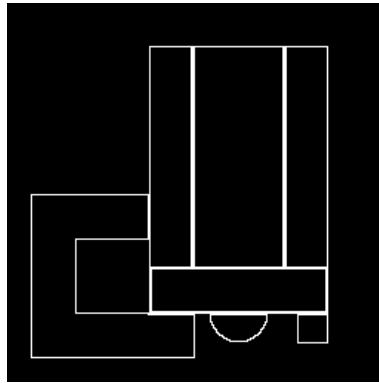

Figure 5.11: Basilica: boundary layer (white).

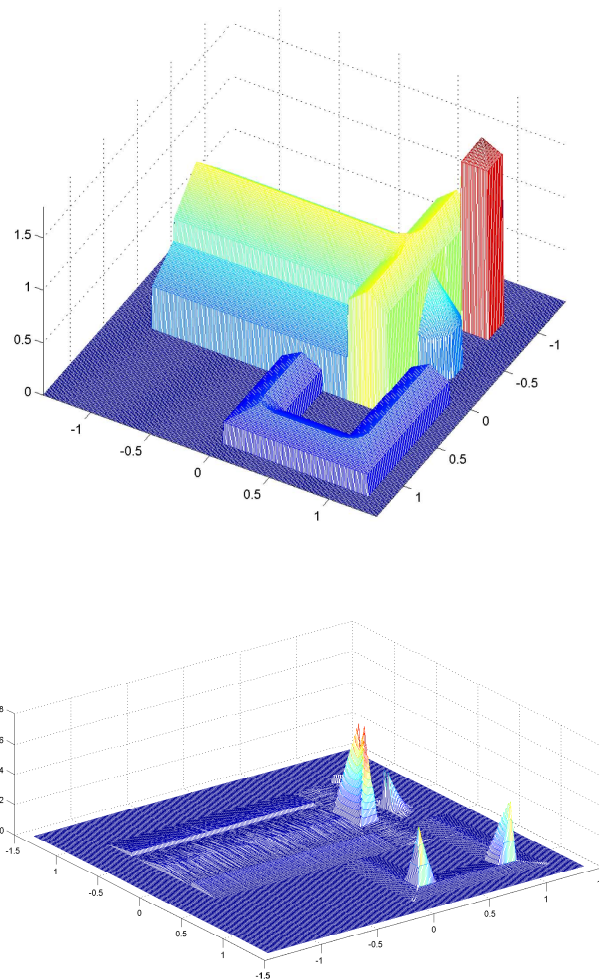

Figure 5.12: Basilica: reconstructed shape and modulus of the error.

## 5.2 Optimization problems with state constraints

### 5.2.1 Theoretical background

One major interest in view of real applications is to see how state constraints can be included in the model. In practical problems, the system has often to satisfy some restrictions (e.g. on the velocity or on the acceleration, or some obstacles through the domain) which can be written as state constraints for the dynamics of the control problem associated to the equation.

We briefly present here, a classical case of well posedness of the problem with state constraints.

We will introduce such constraints in our infinite horizon problem. Let  $\Omega$  be an open bounded convex subset of  $\mathbb{R}^N$  with regular boundary ( $n(x)$  being its outward normal at the point  $x \in \partial\Omega$ ). For any initial position  $x \in \bar{\Omega}$ , we require that the state remains in  $\bar{\Omega}$  for all  $t \geq 0$ . As a consequence we will consider admissible with respect to the state constraint only the (open-loop) control functions such that the corresponding trajectory of the dynamical system

$$\begin{cases} \dot{y}(t) = b(y(t), a(t)), & t > 0 \\ y(0) = x \end{cases} \quad (5.13)$$

never leaves  $\bar{\Omega}$ . We will denote by  $\mathcal{A}(x)$  such a subset of  $\mathcal{A}$ , i.e., for all  $x \in \bar{\Omega}$  we define

$$\mathcal{A}(x) \equiv \{\alpha(\cdot) \in \mathcal{A} : y_x(t, \alpha(t)) \in \bar{\Omega}, \forall t \geq 0\} \quad (5.14)$$

where  $y_x(t, \alpha(t))$  denotes the solution trajectory of (5.13) corresponding to  $\alpha$ . The value function for the constrained problem is

$$v(x) = \inf_{\alpha \in \mathcal{A}(x)} J_x(\alpha) \quad (5.15)$$

with

$$J_x(\alpha(\cdot)) = \int_0^\infty f(y_x(t; \alpha(\cdot)), a(t)) e^{-\lambda t} dt. \quad (5.16)$$

By the theory of, for example [3], with a regular boundary ( $\partial\Omega$  of class  $C^2$  and compact) and the key condition (*Soner's condition*)

$$\inf_{\alpha \in \mathcal{A}} b(x, a) \cdot n(x) < 0 \quad \text{for all } x \in \partial\Omega \quad (5.17)$$

we know that  $v$  is the unique constrained viscosity solution of

$$\lambda u(x) + \sup_{x \in A} \{-b(x, a) \cdot Du(x) - f(x, a)\} = 0. \quad (5.18)$$

In order to understand the problem it is useful to note that at each internal point we can choose any control in  $A$  since, at least for a small time, we can move in any direction without leaving  $\Omega$ . On the other hand, at each point on  $\partial\Omega$  not all the controls in  $A$  are allowed since some of them correspond to directions pointing outward with respect to the constraint  $\bar{\Omega}$ . This means that the set of admissible controls will depend on  $x$  (in a rather irregular way if we do not make

additional assumptions on the boundary of  $\Omega$ ), and the “right equation” for the value function should be:

$$\lambda u(x) + \sup_{x \in A(x)} \{-b(x, a) \cdot Du(x) - f(x, a)\} = 0. \quad (5.19)$$

where

$$A(x) = \begin{cases} A & \text{for } x \in \Omega \\ \{a \in A : b(x, a) \text{ points inward the constraint}\} & \text{for } x \in \partial\Omega. \end{cases} \quad (5.20)$$

Thought the hypothesis of regularity on  $\partial\Omega$  we can rewrite the above definition as

$$A(x) = \{a \in A : b(x, a) \cdot n(x) < 0\}, \quad \text{for any } x \in \partial\Omega. \quad (5.21)$$

Note that the Soner’s condition (5.17) guarantees that  $A(x)$  is not empty for any  $x \in \bar{\Omega}$ .

We propose an alternative technique which was able to solve these kinds of constrained problems without the request of the Soner condition. For doing this, we use the results obtained on Hamilton Jacobi equations with discontinuous running cost  $f$ .

We consider the constrained problem as a problem without constraints but with a running cost very high on the constraint.

We take, for example, an infinite horizon problem in  $\Omega$  open bounded subset of  $\mathbb{R}^n$  and a closed region  $\Gamma \subset \Omega$  where we can not pass with the trajectories of the dynamical system. We introduce the following running cost

$$g(x) = \begin{cases} f(x) & \text{if } x \in \Omega \setminus \Gamma \\ \frac{1}{\epsilon} & \text{if } x \in \Gamma. \end{cases} \quad (5.22)$$

We want now to show the following proposition:

**Proposition 5.1.** *We have that the solution of the equation*

$$\lambda v_\epsilon(x) + \sup_{x \in A} \{-b(x, a) \cdot Dv_\epsilon(x)\} = g(x) \quad x \in \Omega \quad (5.23)$$

*coincides for every  $x \in \Omega \setminus \Gamma$ , to a solution of the constrained problem*

$$\lambda u + \sup_{x \in A} \{-b(x, a) \cdot Du(x)\} = f(x) \quad x \in \Omega \setminus \Gamma. \quad (5.24)$$

*Proof.* We fix a  $\epsilon > 0$  small.

We consider an optimal trajectory  $y_x(t)$  for the unconstrained problem, from a point  $x \in \Omega \setminus \Gamma$ . We divide on two different situations:

- all the points of the trajectory  $y_x(t)$  are contained in  $\Omega \setminus \Gamma$ . In this case, for definition, the solution  $v_\epsilon$  and  $u$  are coincident, from the fact that are the minimum of the same functional; i.e.

$$v_\epsilon(x) = \int_0^\infty g(y_x(t))e^{-\lambda t} dt = \int_0^\infty f(y_x(t))e^{-\lambda t} dt = u(x). \quad (5.25)$$

- they exist two values  $t_1, t_2 \in (0, +\infty]$  such that for  $s \in [t_1, t_2]$  we have  $y_x(t) \in \Gamma$ . We can show that  $y_x(t)$  can not be an optimal trajectory for the unconstrained problem, for a  $\epsilon > 0$  sufficiently small.

We define a trajectory  $z_x(t)$  in the following way

$$z_x(t) = \begin{cases} y_x(t) & \text{if } x \in \Omega \setminus \Gamma \\ \gamma(t) & \text{if } x \in \Gamma. \end{cases} \quad (5.26)$$

where  $\gamma(t)$  is a whichever curve contained in  $\Omega \setminus \Gamma$  and that continuously connect  $y_x(t_1)$  and  $y_x(t_2)$ . We have that

$$\begin{aligned} \int_0^{+\infty} f(z_x(s))e^{-\lambda s} ds &= \int_0^{t_1} f(y_x(s))e^{-\lambda s} ds + \int_{t_1}^{t_2} f(y_x(s))e^{-\lambda s} ds + \int_{t_2}^{+\infty} f(y_x(s))e^{-\lambda s} ds < \\ &\int_0^{t_1} f(y_x(s))e^{-\lambda s} ds + \int_{t_1}^{t_2} \frac{1}{\epsilon} e^{-\lambda s} ds + \int_{t_2}^{+\infty} f(y_x(s))e^{-\lambda s} ds = \int_0^{+\infty} g(y_x(s))e^{-\lambda s} ds \end{aligned} \quad (5.27)$$

so  $y_x(t)$  is not an optimal trajectory. We came back to the previous case.

□

**Remark 5.2.** We can also observe that Proposition 5.1 is true for  $\epsilon < \frac{1}{\max_{x \in \Omega \setminus \Gamma} u(x)}$ , saied  $u(x)$  the solution of the unconstrained problem. We can verify that substituting  $\epsilon$  on (5.27) and observe that it is always valid.

## 5.2.2 Simulations

In the following we deal with some optimization problems with constraints using the techniques introduced in previous chapters.

### Solving labyrinths

We propose to use our results on HJ equations on discontinuous data to solve a labyrinth. We propose two different approaches. In the first we can think about a labyrinth as a minimum time problem with constraints, that are the walls. In this case, from the fact that the dynamics is isotropic, the Soner's condition is verified, so we could deal also to this problem with the classical theory of HJ with constraint. This is an alternative approach. In the second one, we build a graph that modelize the labyrinth, and we solve a minimum time problem on it. Obviously these two different approaches solve two different problems, from the fact that we use a different model in every case.

We consider the labyrinth  $I(x)$  as a digital image with  $I(x) = 0$  if  $x$  is on a wall,  $I(x) = 0.5$  if  $x$  is on the target,  $I(x) = 1$  otherwise. We propose to solve the labyrinth shown in Figure 5.13 where the gray square is the target.

We solve the eikonal equation

$$|Du(x)| = f(x) \quad x \in \Omega \quad (5.28)$$

with the discontinuous running cost

$$f(x) = \begin{cases} \frac{1}{4} & \text{if } I(x) = 1 \\ M & \text{if } I(x) = 0. \end{cases} \quad (5.29)$$

We are in the Hypothesis of Chapter 2 so we use the numerical scheme proposed in that chapter. We obtain the value function shown in Figure 5.14. We have chosen  $dx = dt = 0.0078$ ,  $M = 10^{10}$ .

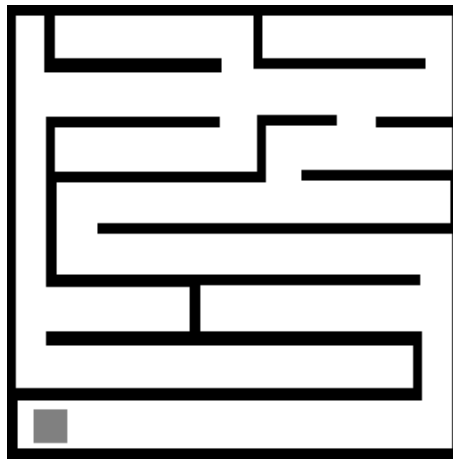

Figure 5.13: A labyrinth as a digital image.

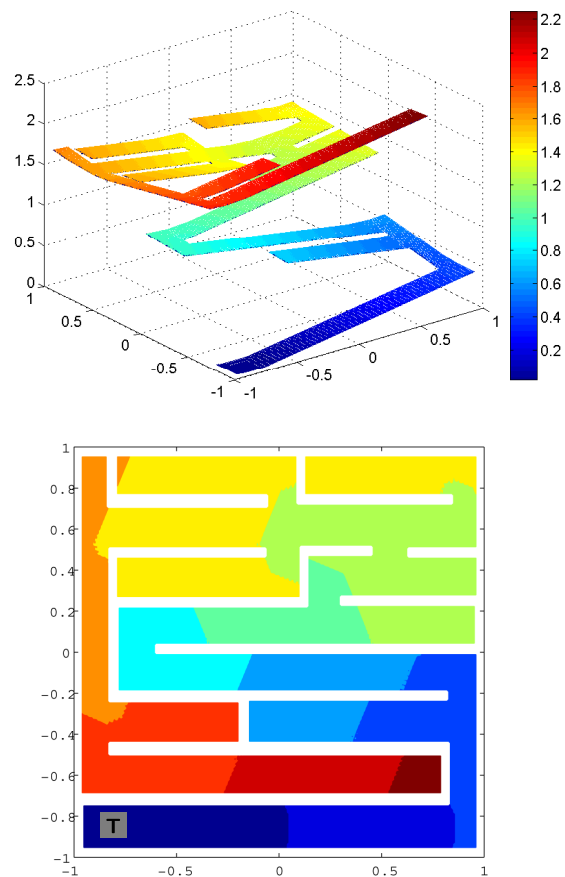

Figure 5.14: Mesh and level sets of the value function for the labyrinth problem.

The second approach that we want to show uses the results for an eikonal equation on a graph, results presented in Chapter 4.

We build a graph  $\Gamma$  that modelizes our labyrinth as shown in Figure 5.15 after this we impose  $f(x) \equiv 1$  on  $\Gamma$ , so we can use the method discussed in Chapter 4. We chose  $dt = 0.05$  and we obtain the result shown on Figure 5.16.

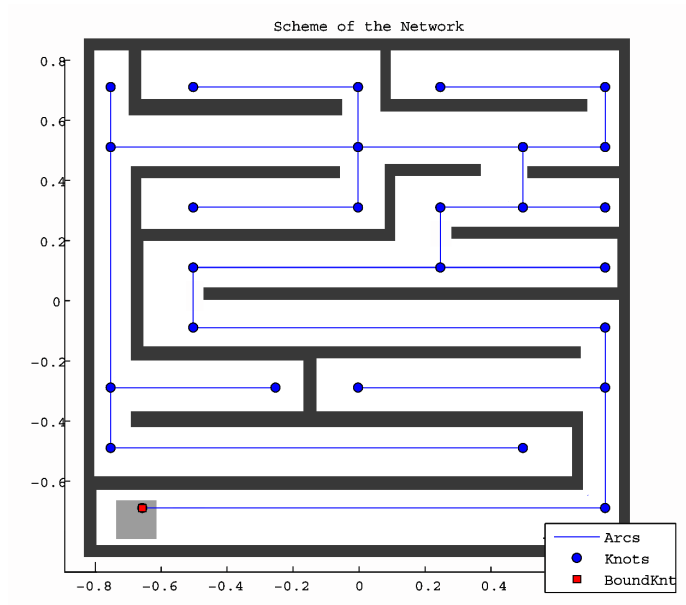

Figure 5.15: The graph that modelizes the labyrinth.

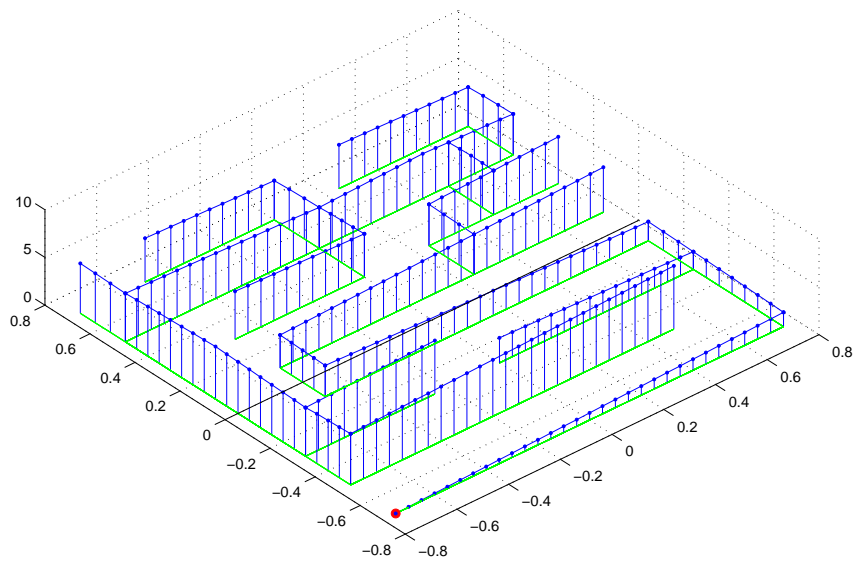

Figure 5.16: Value function on the Graph.



**Constraints without Soner's condition**

Here we use the approach introduced above for an optimization problem where the Soner's condition fails.

We consider the domain  $\Omega = [-1, 1]^2 \setminus C$ , where  $C = [-0.2, 0] \times [-1, 0]$ , and the dynamics  $b(x, a) = (a_1, 0)$ . We can show that the boundary  $\partial C_1 = [-0.2, 0] \times \{0\}$  does not verify the Soner's condition, for example

$$b(x, a) \cdot n(x) = (a_1, 0) \times (0, 1) \equiv 0 \quad x \in \partial C_1. \quad (5.30)$$

As shown before, we modelize the constraint using the function cost  $f$ . We impose the discontinuous running cost

$$f(x) = \begin{cases} 1 & \text{if } x \in \Omega \\ M & \text{if } x \in C. \end{cases} \quad (5.31)$$

we use, then, the following boundary conditions

$$u(x) = \begin{cases} 0 & \text{if } x \in \{-1\} \times [-1, 1] \\ 1 & \text{if } x \notin \Omega. \end{cases} \quad (5.32)$$

so, we can see at this problem as a minimum time problem with constrains where the target is  $\mathcal{T} = \{-1\} \times [-1, 1]$ .

We have a numerical approximation of the solution of the problem, shown in Figure 5.17. In the test we have  $dx = 0.04$  and  $dt = 0.02$ . We take also  $M = 10^{10}$ .

Obviously, there will be some points  $x \in \Omega$  that are outside the reachable set of the problem, in which we can not define a finite solution for  $M \rightarrow +\infty$ .

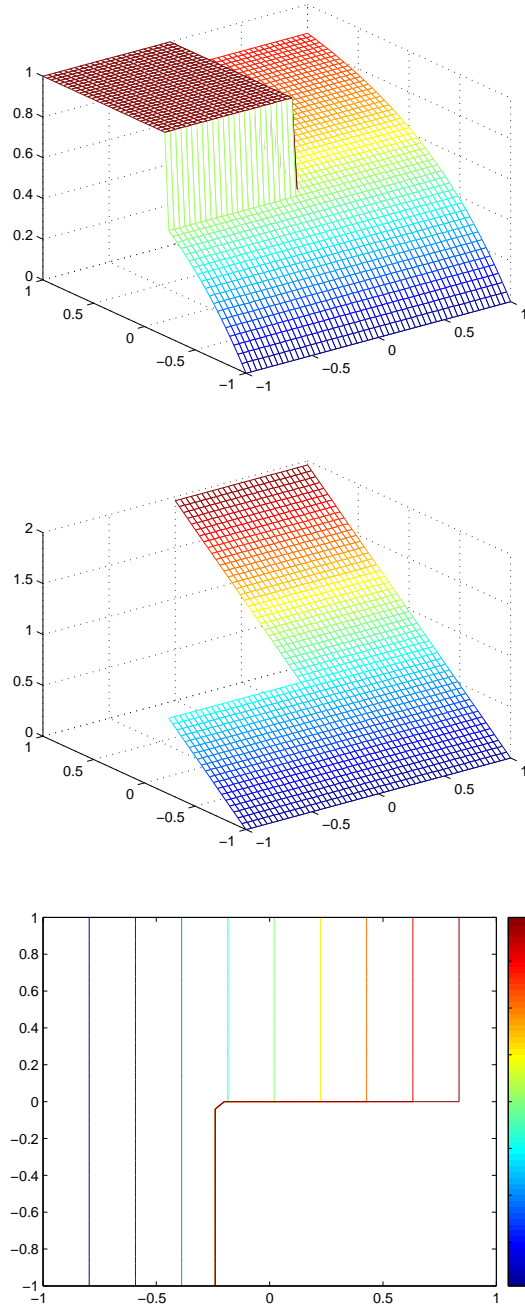

Figure 5.17: Function  $V$  (Kruscov transformed),  $U$  (mesh and level sets).

### Sail Optimization

Here we want to present an application of optimization theory to the research of optimal trajectories in sail boat race.

A sailboat has some restrictions to his choice of trajectories, because of it can not move with an upwind angle, less than  $\alpha$ . The angle  $\alpha$  is a variable that depend from the kind of the boat, the speed of the wind, and the ability of the helmsman. Typically, we want to minimize the time of arrival on a waypoint (buoy) which is placed upwind. So we can not move directly in the direction of the target, but we have to alternate some pieces of trajectory moving to the left side and to the right. This is the typical *beating* (to windward).

In our model we introduce the dynamic system

$$\begin{cases} \dot{y}(t) = b(y(t), a(t)), \\ y(0) = x \end{cases} \quad (5.33)$$

where, saied  $w = [w_1, w_2]$  the direction of wind, the function  $b$  is

$$b(y, a) = \begin{cases} a & \text{if } a \cdot w \leq \cos(\alpha) \\ 0 & \text{otherwise} \end{cases} \quad (5.34)$$

We impose the target set  $\mathcal{T} = \{(0, 1)\}$ , and a constant running cost equal to one.

In our first simulation we consider the case of constant wind  $w = [0, -1]$ . We can observe in Figure 5.18 the results. In this figure we have also traced the optimal trajectories starting from the start, that is the line  $x_2 = -0.9$ . For every starting point we have traced in blue, the trajectories that choose preferably the left side of the race field and in red the ones that prefer the right side. We have to remark that for every starting point the blue trajectory and the red one are both optimal. Are also optimal the other trajectories with optimal angle with respect to the wind and included between the red and the blue one.

In the second simulation we change just the wind. We suppose that the vector  $w$  is the following:

$$w(x) \begin{cases} (0, -1) & \text{if } x_2 \leq -0.3 \\ (\cos(\frac{5}{4}\pi) \sin(\frac{5}{4}\pi)) & \text{if } x_2 \geq 0.3 \\ (\cos(\frac{11}{8}\pi) \sin(\frac{11}{8}\pi)) & \text{otherwise .} \end{cases} \quad (5.35)$$

This fact change prominently the situation. As it is shown in Figure 5.19 from the starting points where there is just one trajectory, the oprimal choice is unique, where there are sections of the same that have a different red way and blue one, there are possible infinity choices of optimal paths.

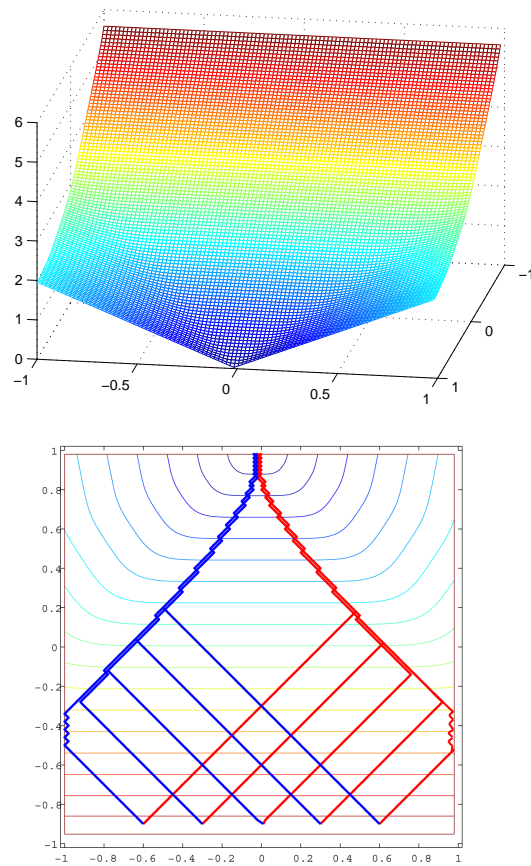

Figure 5.18: Sail Optimization: solution and optimal trajectories.

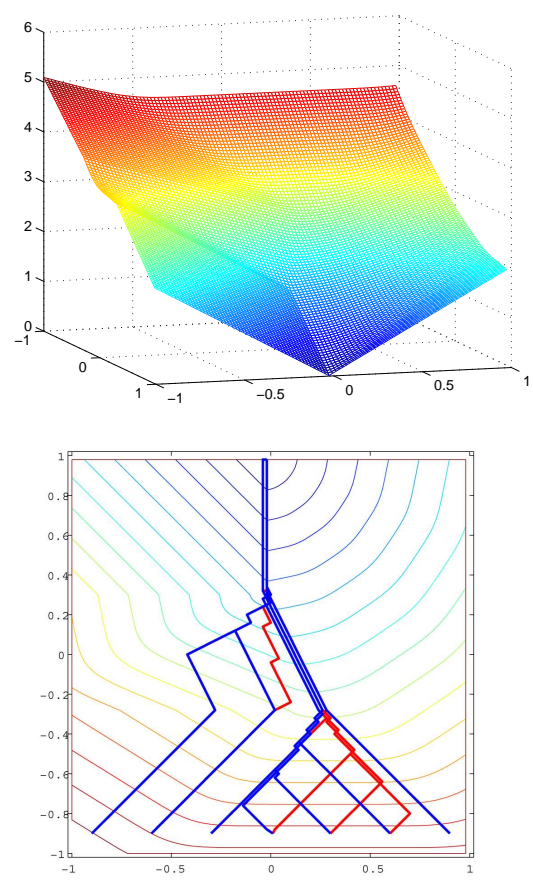

Figure 5.19: Sail Optimization: solution and optimal trajectories with changes of wind.

## 5.3 Front Propagation in Discontinuous Media

### 5.3.1 Theoretical background

Here we briefly present some basic concepts of the theory of curve evolution.

We consider curves to be deforming in time. Let  $\mathcal{C}(\tilde{p}, t) : S^1 \times [0, T) \rightarrow \mathbb{R}^2$  denote a family of closed (embedded) curves, where  $t$  parameterizes the family and  $\tilde{p}$  parametrizes the curve. Assume that this family of curves obeys the following PDE:

$$\frac{\partial \mathcal{C}(\tilde{p}, t)}{\partial t} = a(\tilde{p}, t)\tau(\tilde{p}, t) + c(\tilde{p}, t)n(\tilde{p}, t) \quad (5.36)$$

with  $\mathcal{C}_0(p)$  as the initial condition. Here  $\tau$  and  $n$  are, respectively, the unit tangent and the inward unit normal. This equation has the most general form and means that the curve is deforming with  $a$  velocity in the tangential direction and  $c$  velocity in the normal direction. If we are just interested in the geometry of the deformation, but not in its parametrization, this flow can be further simplified following the result of Epstein and Gage [21], i.e., if  $c$  does not depend on the parametrization, then the image of  $\mathcal{C}(\tilde{p}, t)$  that satisfies equation (5.36) is identical to the image of the family of curves  $\mathcal{C}(p, t)$  that satisfies

$$\frac{\partial \mathcal{C}(p, t)}{\partial t} = c(p, t)n(p, t). \quad (5.37)$$

In other words, the tangential velocity does not influence the geometry of the deformation, just its parametrization.

Curves and surfaces can be, often, represented in an implicit form, as level sets of a higher-dimensional surface. A typical example is the representation of a curve as the level set of a function. The pioneering and fundamental work on the deformation of level sets was introduced in [44]. This implicit representation has a good number of advantages, like stability, accuracy, topological changes allowed etc.

Let us represent this curve as the zero level set of an embedding function  $u(x, t) : \mathbb{R}^2 \times [0, T) \rightarrow \mathbb{R}$ :

$$\mathcal{C}(x, t) = \{(x, t) \in \mathbb{R}^2 \times [0, T) : u(x, t) = 0\} \quad (5.38)$$

differentiating this equation and combining with (5.37), we obtain

$$\frac{\partial u}{\partial t} = c(x, t)|Du| \quad (5.39)$$

where all the level sets of the function  $u$  is moving according to (5.36). With an appropriate initial function  $u_0$ , the zero level set represent the motion of the curve  $\mathcal{C}$ . For details see [50].

If we suppose that  $c(x, t) \equiv c(x) > 0$  we can use an alternative representation. Supposing that  $T(x) : \mathbb{R}^2 \rightarrow [0, +\infty)$  is the function representing the time at which the curve crosses the point  $x$ , we can show that the function time-of-arrival  $T$  satisfies

$$c(x)|DT| = 1. \quad (5.40)$$

the function  $T$  gives a representation of the motion of  $\mathcal{C}$  as level sets, i.e.  $\mathcal{C}(t) = \{x : T(x) = t\}$ . We can use the method proposed in Chapter 2 to give an approximation of the time-of-arrival  $T$  in the case of discontinuous velocities  $c$ .

### 5.3.2 Simulations

We consider a simple situation: there is a *source* of a signal in the point  $(-1, 1)$  and the velocity of the signal is not constant through the whole domain, instead, it varies following the function  $c(x)$ . We can see at this situation as an evolution of a curve (at time zero a point) through an inhomogeneous field of velocities.

We take the following value for the function  $c(x)$

$$c(x_1, x_2) = \begin{cases} 10 & \text{if } -0.2 \leq x_1 \leq 0.2 \\ 1 & \text{otherwise .} \end{cases} \quad (5.41)$$

We get the results shown in Figure 5.20.

We consider also a more complicated situation. This could represent the time of arrival of an electromagnetic radiation of planar waves that moves from a source placed in the point  $(-1, 1)$ . The function  $c(x)$  modelizes the index of refraction of a discontinuous media. We take a  $c(x) : [-1, 1]^2 \rightarrow (0, M]$  as presented in Figure 5.21, of the form

$$c(x_1, x_2) = \begin{cases} 1 & \text{if } x_2 \geq \frac{\log(e+x_1)}{2} + \frac{1}{10} \\ 3 & \text{if } \frac{\log(e+x_1)}{2} - \frac{2}{10} \leq x_2 \leq \frac{\log(e+x_1)}{2} + \frac{1}{10} \\ 20 & \text{if } \frac{e^x}{3} - \frac{1}{5} \leq x_2 \leq \frac{\log(e+x_1)}{2} - \frac{2}{10} \\ 1 & \text{if } x_2 \leq -\frac{3}{20}x_1 - \frac{3}{5} \\ 2 & \text{otherwise .} \end{cases} \quad (5.42)$$

the approximated solution of the problem is presented in Figure 5.21. We can also, mind-ing the physical model, try to reconstruct some trajectories of the waves through the media. [VERIFICARE!] the results are presented in Figure 5.22.

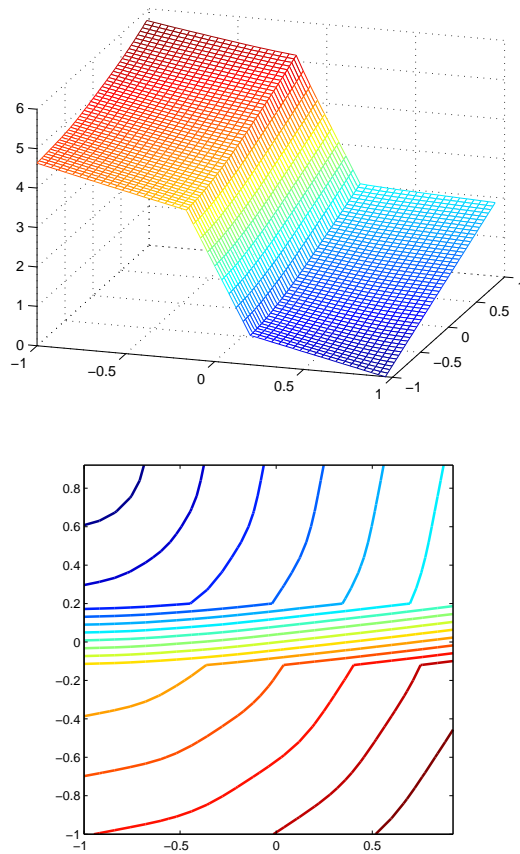

Figure 5.20: Front propagation: solution (mesh and level sets).



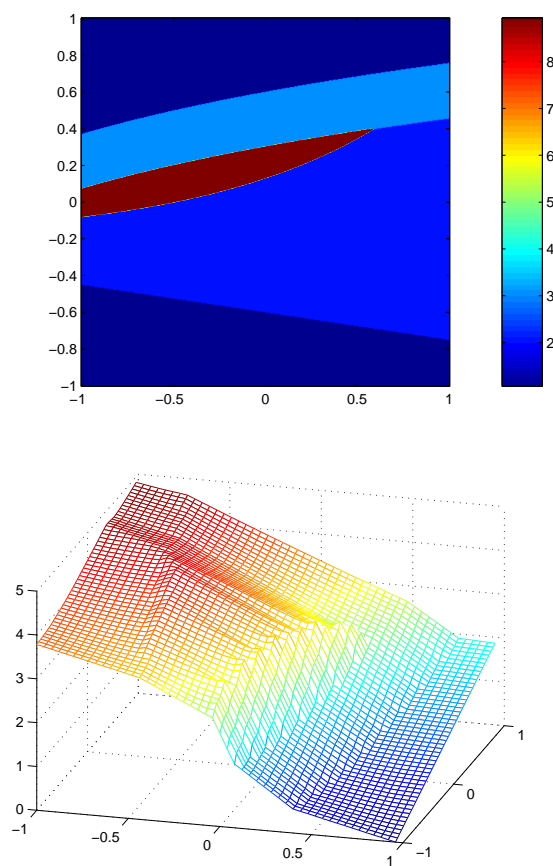

Figure 5.21: Front propagation: velocity field and solution (level sets).

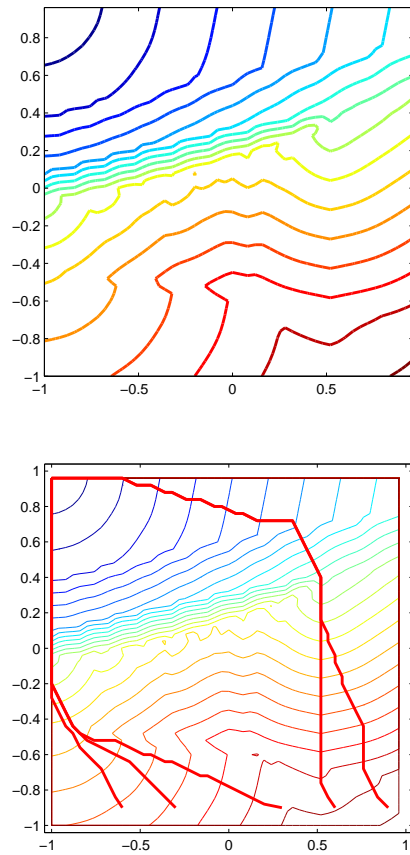

Figure 5.22: Front propagation: level set of the solution and some optimal trajectories.

# Bibliography

- [1] Y. Achdou, F. Camilli, A. Cutrì and N. Tchou *Hamilton-Jacobi equations on networks*. Preprint (2010), available on <http://hal.archives-ouvertes.fr>.
- [2] O. Alvarez, M. Bardi. Ergodicity, stabilization, and singular perturbations for Bellman-Isaacs equations. *Memoirs of the Amer. Math. Soc.* 204, no. 960, 2010.
- [3] M. Bardi, I. Capuzzo-Dolcetta, Optimal Control and Viscosity Solution of Hamilton-Jacobi-Bellmann Equations. *Birkhauser*, Boston Heidelberg 1997.
- [4] M. Bardi, M. Falcone, An approximation scheme for the minimum time function, *SIAM J. Control Optim.*, 28 (1990), 950-965.
- [5] G. Barles. Discontinuous viscosity solutions of first-order Hamilton-Jacobi equations: a guided visit. *J. Nonlin. Anal.* 20 Iss.9, 1993.
- [6] E. N. Barron and R. Jensen. Semicontinuous viscosity solutions for Hamilton-Jacobi equations with convex Hamiltonians, *Comm. Partial. Diff. Eq.* 15, 1713-1742, 1990.
- [7] O. Bokanowsky, N. Forcadel and H. Zidani. L1-error estimates for numerical approximations of Hamilton-Jacobi-Bellman equations in dimension 1. *Math. of Comput.* 79, 271 (2010) 1395-1426.
- [8] R. Bellman, Introduction to the mathematical theory of control processes, Vol. 2. Academic Press, New York, 1971.
- [9] R. Bellman, On a routing problem, *Quart. Appl. Math.* 16, 87-90. 1958. Academic Press, New York, 1971.
- [10] S. H. Benton, The Hamilton-Jacobi Equation: A Global Approach. *Academic Press, New York*, 1977.
- [11] J. von Below, S. Nicaise. Dynaical interface transiction in ramified media with diffusion. *Comm. Partial Differential Equations* 21 no.1-2, 255-279. 1996.
- [12] M.G. Crandall, H. Ishii, and P.L. Lions. Uniqueness of viscosity solutions revisited. *J. Math. Soc. Japan*, 39:581-596, 1987.

- [13] M. G. Crandall and P. L. Lions, Viscosity solutions of Hamilton-Jacobi equations, *Trans. Amer. Math. Soc.*, 277, 1-42, 1983.
- [14] M. G. Crandall and P. L. Lions, Two approximations of solutions of Hamilton-Jacobi equations, *Math. Comp.*, 43:1-19, 1984.
- [15] F. Camilli, A. Festa and D. Schieborn. Shortest paths and Eikonal equations on a graph. *Submitted to the IMACS j. Appl. Num. Math.* <http://arxiv.org/abs/1105.5725v1>
- [16] F. Camilli and L. Grüne, Numerical approximation of the maximal solution of a class of degenerate Hamilton-Jacobi equations, *SIAM J. Numer. Anal.* 38, 1540-1560, 2000.
- [17] F. Camilli and A. Siconolfi: Maximal subsolutions for a class of degenerate Hamilton-Jacobi problems. *Indiana Univ. Math. J.* 48 (1999), 1111-1131.
- [18] K. Deckelnick and C. Elliott. Uniqueness and error analysis for Hamilton-Jacobi equations with discontinuities. *Interfaces and free boundaries.*, 6, 329-349 2004.
- [19] J.D. Durou, M. Falcone and E. Sagona. A Survey of Numerical Methods for Shape from Shading. *Rapport IRIT 2004-2-R, Université Paul Sabatier, Toulouse, France*, 2004.
- [20] E. W. Dijkstra, A note on two problems in connexion with graphs. *Numer. Math.* 1 (1959) 269–271.
- [21] C.L. Epstein and M. Gage. The curve shortening flow. in *Wave Motion: Theory, Modeling, and Computation*, A. Chorin and A. Majda, eds., Springer-Verlag, New York. 1987.
- [22] L.C. Evans. Periodic homogenization of certain fully nonlinear partial differential equations. *Proc. Roy. Soc. Edinburgh Sect.* 120, 245-265. 1992.
- [23] L.C. Evans. A survey of partial differential equations methods in weak KAM theory. *Comm. Pure Appl. Math.* 57, no. 4. 445-480. 2004.
- [24] A. Fathi. Weak KAM Theory in Lagrangian Dynamics. *Cambridge Studies in Advanced Mathematics* 88, Cambridge University Press, 2010.
- [25] M. Falcone and R. Ferretti. Semi-Lagrangian schemes for Hamilton-Jacobi equations, discrete representation formulae and Gordunov methods. *J. Comput. Phys.*, 175, 559-575 2002.
- [26] M. Falcone and R. Ferretti. Convergence Analysis for a Class of High-Order Semi-Lagrangian Advection Schemes *SIAM Journal on Numerical Analysis* Vol. 35, No. 3 (1998), pp. 909-940
- [27] M. Falcone, R. Ferretti, Semi-Lagrangian Approximation Schemes for Linear and Hamilton-Jacobi Equations, SIAM, 2011.
- [28] A. Fathi, A. Siconolfi: PDE aspects of Aubry-Mather theory for quasiconvex Hamiltonians. *Calc. Var. Partial Differential Equations* 22 (2005), 185–228.

- [29] H. Frankowska, Lower semicontinuous solutions of Hamilton-Jacobi-Bellman equations, *SIAM J. Control Optim.*, 31 (1993), 257-272
- [30] W. H. Fleming, R.W. Rishel, Deterministic and Stochastic Optimal Control. *Springer-Verlag*. New York-Heidelberg-Berlin. 1975.
- [31] L. R.Ford Jr., D. R. Fulkerson, *Flows in networks*. Princeton Landmarks in Mathematics. Princeton University Press, Princeton, NJ, 2010.
- [32] B. K. P. Horn, M. J. Brooks (editors), Shape from Shading, *MIT Press*, 1989.
- [33] H. Ishii. Hamilton-Jacobi equations with discontinuous Hamiltonians an arbitrary open sets. *Bull. Fac. Sci. Engrg. Chuo. Univ.*, 28, 33-77 1985.
- [34] H. Ishii. A simple, direct proof of uniqueness for solutions of the Hamilton-Jacobi equations of eikonal type. *Proc. Amer. Math. Soc.*, 100, 2, 247-251 1987.
- [35] H. Ishii. Asymptotic solutions for large time of Hamilton-Jacobi equations in Euclidean n space. *Ann. Inst. H. Poincaré Anal. Non Lin.* 25, 231-266, 2008.
- [36] H. Ishii, H.Mitake: Representation formulas for solutions of Hamilton-Jacobi equations with convex Hamiltonians. *Indiana Univ. Math. J.* **56** (2007), no. 3, 2159-2184.
- [37] H. Ishii, M. Ramaswamy, Uniqueness results for a class of Hamilton-Jacobi equations with singular coefficients, *Communications in Partial Differential Equations*, 20, 2187-2213. 1995.
- [38] J.E. Lagnese, G. Leugering. Modelling of dynamical networks of thin elastic plates. *Math. Methods Appl. Sci.* 16, no. 6 379-407. 1993.
- [39] J.E. Lagnese, G. Leugering, J.P.G. Schmidt. On the analysis and control of hyperbolic systems associated with vibrating networks. *Proc. Roy. Soc. Edinburgh Sect.* 124, no. 1 77-104. 1994.
- [40] J. M. Lasry, P.L. Lions. Mean field games. *Jpn. J. Math.* 2, no.1, 229-260, 2007.
- [41] P.L. Lions. Generalized solutions of Hamilton-Jacobi equations. Pitman, Boston.
- [42] P.L. Lions, E. Rouy, A. Tourin, Shape from shading, viscosity solution and edges, *Numerische Mathematik*, 64, 323-353. 1993.
- [43] G. Lumer: *Espaces ramifiés, et diffusions sur les réseaux topologiques*. C. R. Acad. Sci. Paris Sér. A-B **291** (1980), no. 12, A627-A630.
- [44] S.J. Osher and J. Sethian. Front propagation with curvature dependent speed: algorithms based on Hamilton-Jacobi formulations. *J. Comput. Phys.* 79, 12-49, 1988.
- [45] R.T. Newcomb, J. Su. Eikonal equations with discontinuities. *Differential Integral Equations*, 8, 1947-1960, 1995.

- [46] S. Nicaise. Polygonal interface problems. *Methoden und Verfahren der Mathematischen Physik [Methods and Procedures in Mathematical Physics]*, 39. Verlag Peter D. Lang, Frankfurt am Main, 1993.
- [47] D. Ostrov. Viscosity solutions and convergence of monotone schemes for synthetic aperture radar shape-from-shading equations with discontinuous intensities. *SIAM J. Appl. Math.* 59, 2060-2085. 1999.
- [48] A. Quarteroni, A. Valli, Numerical methods for partial differential equations, *Oxford University Press*, 1999.
- [49] E. Rouy and A. Tourin, A viscosity solutions approach to shape-from-shading. *SIAM J. Numer. Anal.* 29, 867-884. 1992.
- [50] G. Sapiro. Geometric Partial Differential Equations and Image Analysis. Cambridge University Press. 2001.
- [51] D. Schieborn, F. Camilli: Viscosity solutions of Eikonal equations on topological networks, arXiv:1103.4041v1, 2011.
- [52] J.A. Sethian, *Level set methods and fast marching methods. Evolving interfaces in computational geometry, fluid mechanics, computer vision, and materials science*. Second edition. Cambridge Monographs on Applied and Computational Mathematics, 3. Cambridge University Press, Cambridge, 1999.
- [53] P. Soravia. Discontinuous viscosity solutions to the Dirichlet problems for Hamilton-Jacobi equations with convex hamiltonians. *Comm. Partial Diff. Eq.*, 18, 1493-1514, 1993. [soravia eikonale!!]
- [54] P. Soravia. Boundary Value Problems for Hamilton-Jacobi Equations with Discontinuous Lagrangian. *Indiana Univ. Math. J.*, 51,451-77, 2002.
- [55] P.E. Souganidis, Approximation schemes for viscosity solutions of Hamilton-Jacobi equations, *J. Differential Equations*, 57 (1985), 1-43.
- [56] M. Thorup, Undirected single-source shortest paths with positive integer weights in linear time. *J. ACM* 46 (1999), no. 3, 362–394.
- [57] Y.R. Tsai, Y. Giga and S. Osher. A Level Set Approach for Computing Discontinuous Solutions of a Class of Hamilton-Jacobi Equations. *Math. Comp.* 72, 159–181, 2001.
- [58] A. Turin. A comparison theorem for a piecewise Lipschitz continuous Hamiltonian and applications to shape-from-shading. *Numer. Math.*, 62, 75-85, 1992.
- [59] R. Vinter. Optimal Control, *Birkhauser*, Boston, 2000.